

ARCHERY 2023

PRODUCT CATALOG
**BEST-IN-CLASS
PERFORMANCE**

WIAWIS

RTF-DX

WIAWIS 



WIAWIS stands for “Winning Action, Winning Spirit”. It represents the unwavering action and spirit for victory. As a name well suited to the philosophy of WIN&WIN, WIAWIS products are high-end archery bows and they are our representative products of WIN&WIN.





WIAWIS PHILOSOPHY : Quality Differentiation

The story of Win&Win Archery is the story of professional archers who gambled everything to follow their passion.

In 1993 WIN&WIN Co. was established by Mr. Park Kyung Rae and the people who used to be in national archery team. Prior to that, the Korean Archery National Team was seated among the middle world archery ranks in the early 1980s. Mr. Park worked to bring the Korean Archery Team to where it is today; the best archery program in the world. He led Korea to success with their first gold medal at the World Championships in 1985 and with the gold medals at the Olympic in 1988 and at the World Championships in 1991.

Based on its expertise in archery, WIN&WIN has devoted its passion and efforts to make the best bows in the world by actively investing in advanced technology. In 2002, Yamaha archery technology and equipment were introduced to further enhance its technology and know-how. Thus, WIN&WIN has become the top brand in the world as a majority of the athletes from the Olympics and the World Championships are using the WIAWIS Bow from Win-Win. At the Rio Olympic Games in 2016, WIAWIS Bow achieved a gold medal in all categories.



HISTORY OF VICTORY

WIAWIS won the gold medal at the 1999 World Championships. With the best players in the world so far it is loved by the bow that won the medal.

1999

World Archery Championships Men&Women Individual
(Lee Eun-Kyung, Hong Sung-Chil)

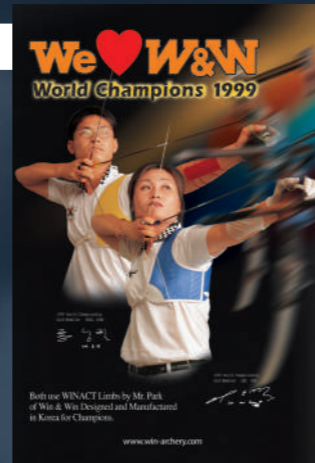

2000

Sydney Olympics Gold Medalist (Team)
New World Recorder (1,379 pts:Nov. 2000)
(Oh Kyo-Mun)
Sydney Olympics Gold Medalist (Yun Mi-Jin)



2003

World Archery Championships Men&Women Individual
(Michele Frangilli, Yun Mi-Jin)

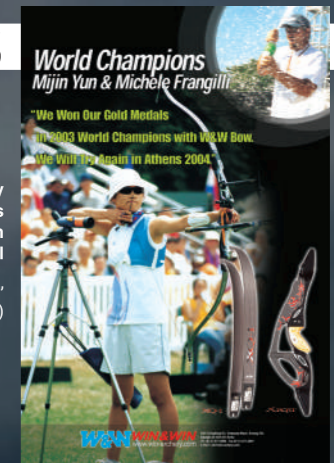

2005



World Archery Championships Men's Individual
(Chung Jae-Hun)

2007



Archery World Cup (Baljinima Tsyrempilov, Dola Banerjee)

2008

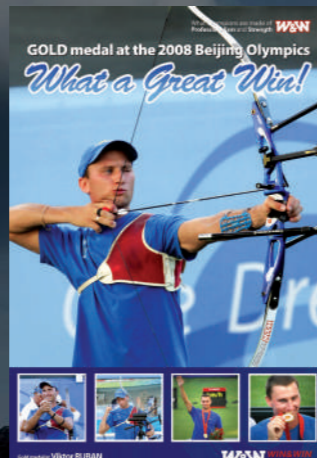

Beijing Olympics Men's Individual (Viktor Ruban)

2009



World Archery Championships Men's Individual
(Lee Chang-hwan)

2010



World Archery Championships Women's Individual
(Van Lamoen Denisse Astrid)

2012



London Olympics Women's individual, Team Gold medalist
(Ki Bo-Bae)

2013

World Archery Championships Men's Individual Gold Medal
(Lee Seung-Yoon)

World Archery Championships Women's Individual (Ki Bo-Bae)

2015

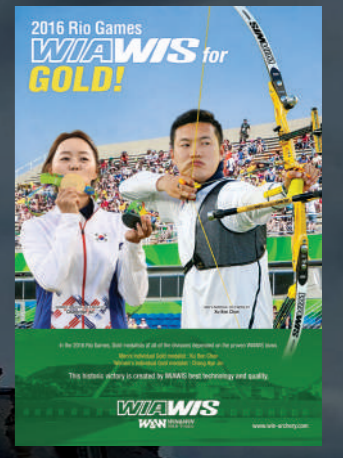

Clean sweep of all Archery Gold Medals at the Rio Olympics
Won Men's & Women's individual
(Chang Hye-jin, Ku Bon-chan)

2016

2017



World Archery Championships Women's Individual (Ksenia Perova)
Women's team (Chang Hye-jin, Choi Mi-sun, Kang Chae-young)

2018



Clean sweep of all Archery Gold Medals at the Archery Worldcup
Woman Gold Silver Bronze / Man Gold
Women Team Gold / Men Team Gold / Mix Team Gold

2019



Clean sweep of all Archery Gold Medals at the World Championships
Woman Gold Silver Bronze / Man Silver Bronze / Women Team Gold / Men Team Gold / Mix Team Gold

2021



2020 Tokyo Olympics
Triple Gold medals- Women's Individual, Women's Team, Mixed Team (An San, Korea)
Double Gold medals- Mixed Team, Men's Team (Kim Je Deok, Korea)
Women's Team Gold medal (An San, Jang Min-hee, Kang Chae-young, Korea)
Men's Team Silver medal (Wei Chun-heng, Deng Yu-Cheng, Chinese Taipei)
Men's Individual & Team Bronze medal (Furukawa Takaharu, Japan)
Women's Team Bronze medal (Charline Schwarz, Germany)

2021 World Archery Championships
Women's Team Gold medal (An San, Jang Min-hee, Kang Chae-young, Korea)
Women's Individual Gold & Bronze (Kang Chae-young, An san)
Mixed Team (An san)
Men's Team Gold (Kim Je-deok)
Men's Individual Silver (Marcus D'almeida)

2022



Clean sweep of all Archery Gold Medals at the World Championships
Woman Gold Silver Bronze / Man Silver Bronze / Women Team Gold / Men Team Gold / Mix Team Gold

WIAWIS REVOLUTION TECHNOLOGY

UNIQUE MATERIALS

Maximizing properties of carbon with applying a high tech nano graphene



Graphene is the material to have won the Nobel Prize and is referred 'the material of dreams'. It is lighter than wood, stronger than diamond as well as the smallest material that mankind has ever discovered. Based on the development of these graphene-applied carbon prepreg,

WIAWIS was able to develop stronger, more accurate and more durable bows by maximizing the performance of the carbon.

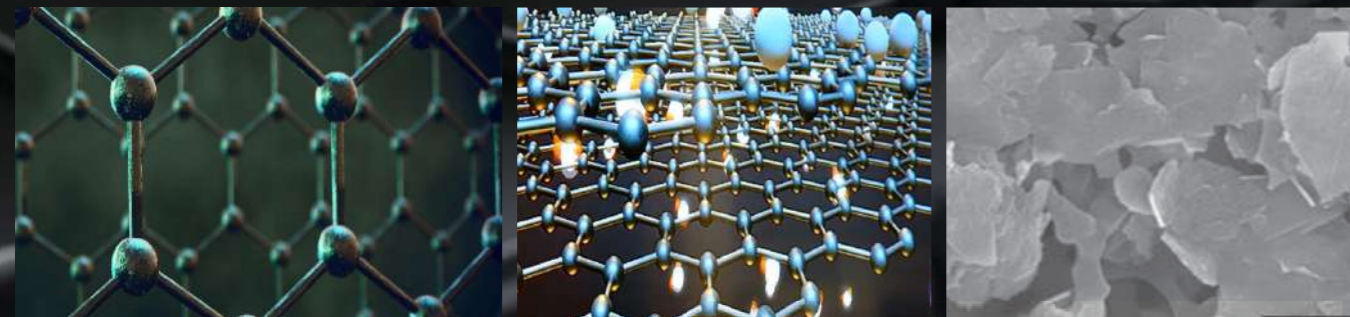

Application of Counter Veil System

A special material laminated in the limb base, Counter veil system efficiently absorbs the shock and vibration in shooting. It reduces unnecessary movement and improves bow accuracy.

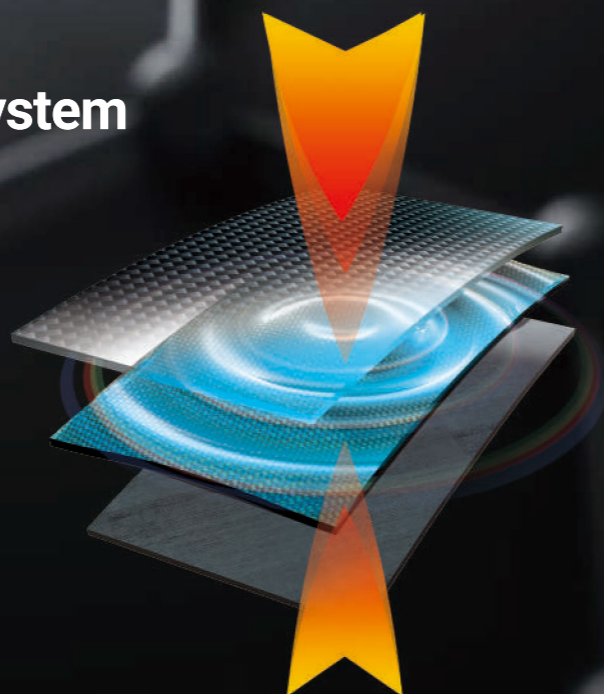

ANALYSIS & DESIGN



reddot design award



WIAWIS bows are planned and designed efficiently by a group of top design experts who have won the Reddot Design Award.



Our expert designers have more than 20 years of knowledge for production/manufacture of WIAWIS bows, as well as experience and know-how as professional archers. WIAWIS bows are created by the best experts from the design to the production of WIAWIS products.





WIAWIS risers and limbs represent the pinnacle of nano carbon technology.

WIN&WIN's carbon technology is excellent at absorbing shock and minimizing unnecessary movement to make shooting more accurate and stable. Better, faster, stronger!



KIM JE DEOK / KOREA

CONTENTS

RISER	CARBON META DX RADICAL PRO TFT-G INNO CXT CX7
	ALUMINUM ATF-DX ATF-X WINEX
LIMBS	MXT-XP FOAM MXT-XP WOOD NS-G FOAM NS-G WOOD CX7 FOAM CX7 WOOD WINEX

ACCESSORIES

APPAREL

The Way to Victory!

2023 WIAWIS RISER



FEDERICO MUSOLESI / ITALY

CARBON RISER



META DX

RADICAL PRO

TFT-G

INNO CXT

CX7

ALUMINUM RISER

2023 NEW



ATF-DX

ATF-X

WINEX

META DX TECHNOLOGY

NOBEL PRIZE-WINNING GRAPHENE

META riser is made of graphene carbon which is the best carbon material of WIAWIS. It improves the shock resistance caused by shooting and therefore minimizes unnecessary movement, resulting in improved arrow grouping.



BETTER TORQUE FREE CONSTRUCTION

In addition, Special Steel has been inserted to assist in the reduction of vibration and torsion caused when force is transferred from the bow limbs. The Mathews® EHS™ dampening system has been introduced to improve stability of the shoot feeling, accuracy of the bow and ultimately arrow grouping.

ADVANCED STRUCTURAL DESIGN

Meta DX riser has been designed to reduce the shock and vibration after shooting more effectively. The structural design is more dynamic and aesthetically pleasing than previous design products.

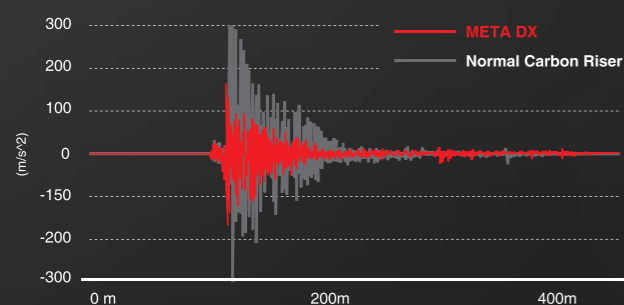

META DX

META DX features are functionally upgraded with ground-breaking structural design. The special design of the META DX riser adapts materials developed by WIAWIS technology maximizing accuracy and stability at the moment of shooting.



TECHNICAL SPECIFICATIONS

LENGTH	25 inches
WEIGHT	1380 g
TYPE	RH / LH
MATERIAL	Graphene / Nano Carbon

 META CAP weighs 9grams and once you change all 3 original harmonic dampers, you can reduce a riser weight by a total of 47grams. (Ref. MATHWEWS® EHS™ HARMONIC DAMPER weighs 32grams and MATHWEWS® HARMONIC DAMPER weighs 10grams respectively.)

COLORS



All the weight parts need to be removed for the Barebow division (The rubber parts can be inserted into the riser)

TILLER BOLT SIZE	13 mm
DEFAULT GRIP	

RADICAL PRO TECHNOLOGY

SPECIALLY DESIGNED CENTER SUSPENSION OF RADICAL PRO

The Radical Pro riser has been designed like no other riser specifically to reduce vibration and bow torque when shooting. Unlike a dampener that absorbs vibration after shooting but has no effect on bow torque at the moment of shooting. Ultimately this assists to better arrow grouping by drastically reducing bow torque.

Radical Pro riser shows improved properties on vibration absorption at the same 44lbs limbs set-up.

HERE'S THE RADICAL PRO NANO CARBON RISER

We use nano carbon applied graphene on both the riser and the limbs.



RADICAL PRO

HIGHEST SHOCK ABSORPTION

RADICAL PRO riser is made by nano carbon technology applying the innovative material of graphene. Its Center Suspension improves rigidity and durability while effectively controlling shooting shock and minimizing bow torque. Also, a specially designed Sound Amplification board for the clicker provides clear sound in 3000~6000Hz that is the most audible frequency to the archer and making clicker timing regular. This will enhance better arrow grouping.

TECHNICAL SPECIFICATIONS

LENGTH	25 inches
WEIGHT	1300 g
TYPE	RH / LH
MATERIAL	Graphene / Nano Carbon

COLORS



TILLER BOLT SIZE	13 mm
DEFAULT GRIP	7



TFT-G TECHNOLOGY



GRAPHENE PREPREG

The TFT-G handle, which has high stiffness and durability due to using nano graphene prepreg, is the world's first handle to improve the overall balance. This improves grouping and reduces bow torque by more than two times compared to ordinary aluminum handles.

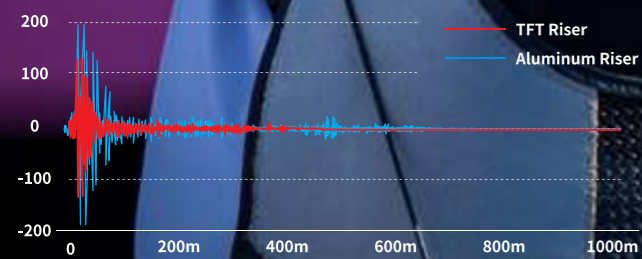

GRAPHENE DAMPER

Made of nano graphene prepreg dispersed in high molecular epoxy to absorb shooting shock and vibration to assist with stabilizing the shot.

CHARLINE SCHWARZ | GERMANY

TFT-G

GRAPHENE MAXIMIZING SHOCK-RESISTANCE AND VIBRATION DAMPING

TFT-G riser is made of cutting-edge carbon molding technology using graphene carbon materials. In the sight-window area of the riser special steel machined in the form of H-beam has been used to improve strength and rigidity in the most vulnerable part of the riser. The H-beam minimizes the torque caused by the difference between the upper and lower balance/configuration of the riser, which will enhance arrow grouping.

In addition, the special graphene damper on the center of the riser is designed to minimize shock vibration and error during the shot which make the archer's sense of shooting maximized.

TECHNICAL SPECIFICATIONS

LENGTH	25 inches
WEIGHT	1320 g
TYPE	RH / LH
MATERIAL	Graphene / Nano Carbon

COLORS



TILLER BOLT SIZE	13 mm
DEFAULT GRIP	7



INNO CXT

UNIQUE DESIGN OPTIMISING CARBON

The CXT riser has been in production for many years and has been a very popular riser winning medals at all levels.

TECHNICAL SPECIFICATIONS

LENGTH	23 inches	25 inches	27 inches
WEIGHT	1120 g (LIGHT:1070 g)	1200 g (LIGHT:1150 g)	1260 g (LIGHT:1210 g)
TYPE	RH	RH / LH	RH
MATERIAL	Nano Carbon		



Weight Control System
* 4 flat weights are included
(1 flat weight : 25 g)

TILLER BOLT SIZE 12 mm
DEFAULT GRIP 

COLORS



CX7

The CX7 riser is designed and manufactured with carbon prepreg where carbon fiber is distributed evenly in all directions. The rigid design emphasizes the features of the stable carbon material riser to minimize shooting errors.

TECHNICAL SPECIFICATIONS

LENGTH	25 inches
WEIGHT	1300 g
TYPE	RH / LH
MATERIAL	Carbon Composite



COLORS



TILLER BOLT SIZE 13 mm
DEFAULT GRIP 

ATF-DX TECHNOLOGY

APPLIED EHS DAMPING SYSTEM

ATF-DX was designed by combining technology and experience of WIAWIS and completed with precision. The EHS damping system was introduced to reduce shock and vibration at the moment of release. With the EHS damper, the shock and vibration of shooting is greatly reduced, making it possible for an archer to obtain more stability of their shot.

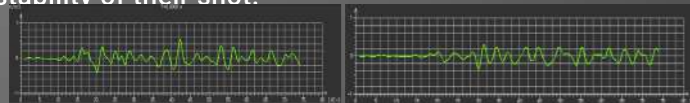

Without dampers

Using dampers

SPECIALIZED PLASTIC ADDED AS A COMPONENT FOR THE ALUMINUM HYBRID BLOCK

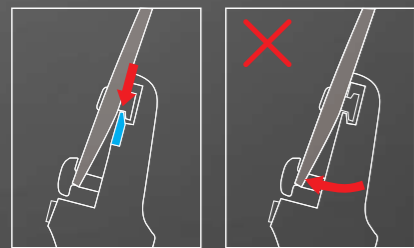

After release, the impact from the string is directed vertically from the limb's contact point of the riser block. Super engineered plastic with excellent mechanical properties of the block adds resistance to heat, shock, along with wear and tear.



Minimizes shock and vibration occurring at the moment of release by about 8%, Noise prevention by the friction of metal.

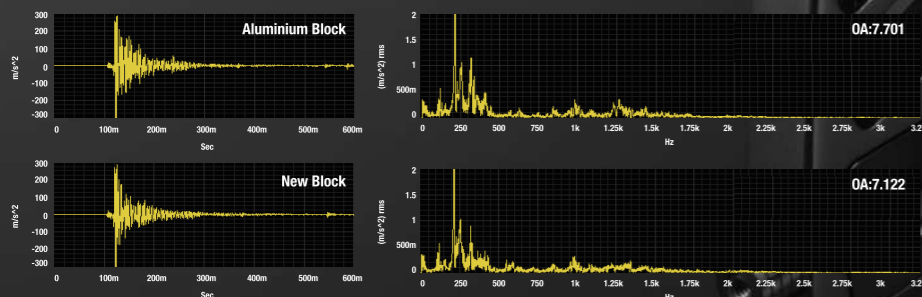

ATF-DX

IT MINIMIZES TORQUE ; UNNECESSARY MOVEMENT OF THE BOW

ATF-DX introduces the same dampers used in the META-DX handle to increase effective reduction in vibration caused by the impact at the moment of shooting. It minimizes unnecessary movement of the bow to assist with improvement of arrow grouping. The ergonomically designed grip provides a positive sensory feeling, increasing stability. Rest plates are adjustable as 4 levels to suit your arrows and your tuning.



TECHNICAL SPECIFICATIONS

LENGTH	25 inches, 27 inches
WEIGHT	1360 g / 1430 g
TYPE	RH / LH
MATERIAL	Aluminum / CNC machining

COLORS



TILLER BOLT SIZE	13 mm
DEFAULT GRIP	8



ATF-X TECHNOLOGY

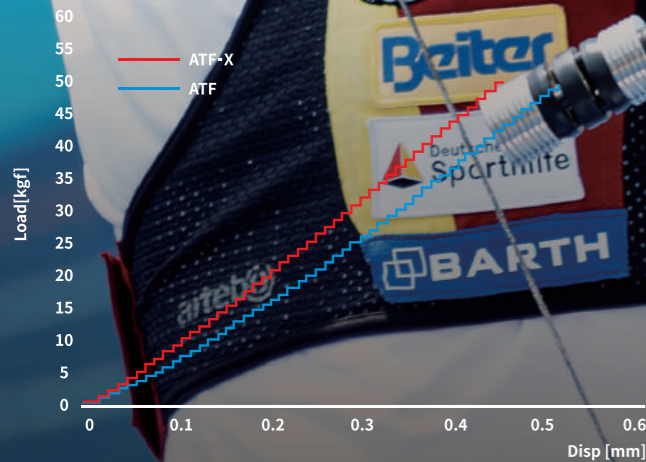

ATF-X FEATURES

To enhance the features of the aluminum riser while maintaining the same net weight as the ATF riser, it efficiently improved stiffness and anti-twisting so that it is more stable shooting with less vibration and reduced bow torque.

When shooting with ATF and ATF-X risers on the same 44lb limbs, ATF-X riser is less vibration than ATF riser.

ATF-X

ANTI-TORSIONAL DESIGN TO MAKE SHOOTING STABLE

ATF-X is a reinforced model of the ATF riser which was used by top world class athletes. Through the balance of the riser design, ATF-X makes the shooting feel more powerful. Anti-torsional 45-degree cross design.

TECHNICAL SPECIFICATIONS

LENGTH	25 inches, 27 inches
WEIGHT	1280 g, 1350 g
TYPE	RH / LH
MATERIAL	Aluminum / CNC machining

COLORS



TILLER BOLT SIZE	13 mm
DEFAULT GRIP	

WINEX

THE IDEAL BOW FOR SERIOUS SHOOTING

WINEX riser is a long-running riser which is designed to be faithful to the most basic role of the riser. Several new designs have been introduced and have been loved by many archers.

TECHNICAL SPECIFICATIONS

LENGTH	23 inches	25 inches
WEIGHT	1080 g	1140 g
TYPE	RH	RH / LH
MATERIAL	Aluminum	



COLORS



TILLER BOLT SIZE	13 mm
DEFAULT GRIP	



INNOVATIVE WIAWIS

WIAWIS's technology through differentiated materials, design and manufacturing skills with serious quality control is leading the world in bow innovation.

2023 WIAWIS LIMBS



MARCUS D'ALMEIDA / BRAZIL

2023 NEW



MXT-XP FOAM

MXT-XP WOOD

NS-G FOAM

NS-G WOOD



CX7 FOAM

CX7 WOOD

WINEX

MXT-XP TECHNOLOGY

USE SPECIAL PAINT TO BLOCK INFRARED RAYS

Special paint reflecting infrared rays on the surface of the limbs was used to block the heat rays from sunlight and reduce the temperature effect on the limbs.

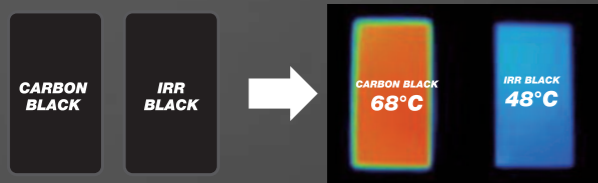

* USE SPECIAL PAINT TO BLOCK INFRARED RAYS : IRR
Reduce the high temperature effect

POUND CHANGING IN FULL-DRAWING

The new MXT-XP limbs maximizes archers' shooting skills and improves arrow grouping by maintaining more consistent power over time at full draw.

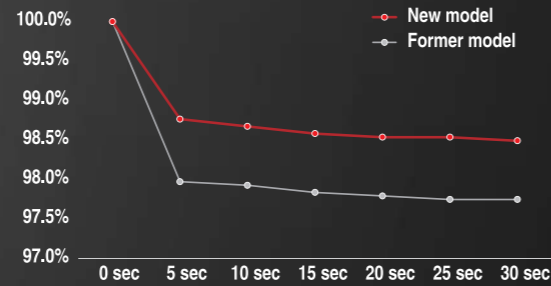

LIMB CURVE TO GIVE STABILITY AND SMOOTHNESS

WIAWIS 2023 NEW limbs MXP-XP were developed based on accumulated data that has analyzed the correlation between stability and speed according to the strain distribution of the limbs.

They feature 1) the optimized curve to increase the speed and stability with minimizing the stress of the limbs. 2) They were designed to give smoothness in drawing. 3) better concentration and better arrow grouping by improved limbs anti-torsion after shooting. While maximizing accuracy and stability, which are main characteristics of WIAWIS bows. Even for the archer tries to shoot first, MXT-XP were designed to be easy to control and comfortable in short period.



More strain distribution on MXT-XP

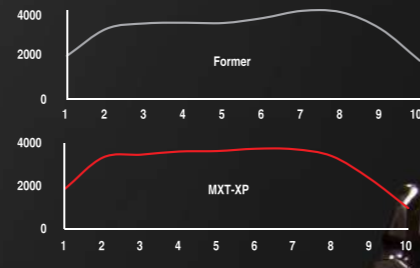

More strain distribution on MXT-XP

F-X CURVE

MXT-XP limbs maintains and enhances the key functions of the bow such as arrow speed, grouping, and forgiving, while maintaining its smoothness.

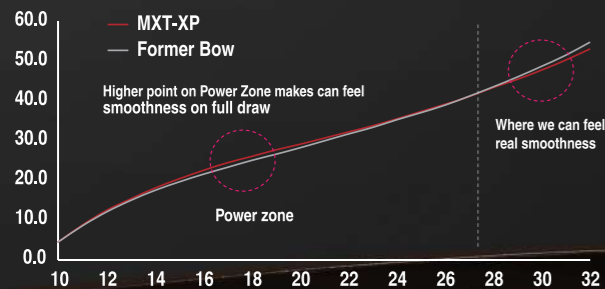

MXT-XP FOAM

MXT-XP limbs have the most stable design since launching the MXT limb series, which gives the feeling of stable shooting with anti-twisting and smooth drawing. Also, special paint is used to enhance heat resistance on the surface of the limbs to enable consistence performance during changing weather conditions.

TECHNICAL SPECIFICATIONS

LENGTH	Short, Medium, Long
WEIGHT	28 to 48 lbs (2 lbs increment)
MATERIAL	Graphene Foam Core / High Modulus Carbon



MXT-XP WOOD

TECHNICAL SPECIFICATIONS

LENGTH	Short, Medium, Long
WEIGHT	28 to 48 lbs (2 lbs increment)
MATERIAL	Wood Core / High Modulus Carbon



NS-G TECHNOLOGY

GRAPHENE LIMB BASE

The WIAWIS NS-G limb uses a limb base made of graphene prepreg-dispersed in a high molecular epoxy which has been shown to absorb shock and vibration more efficiently, and help stabilize limb movement after shooting. This new concept of limb construction was solely developed and used by WIN&WIN.

STRAIN-BALANCE TECHNOLOGY

WIN&WIN has enhanced the WIAWIS NS-G limbs in both power and stability by applying Strain-Balance technology. The result of years of research, Strain-Balance technology helps WIN&WIN find the optimal limb flex profile through analyzing the relationship between stability and speed according to the limb flex. The NS-G limbs feature enhanced smoothness while drawing without compromising the arrow speed and accuracy which WIN&WIN is known for.

WIAWIS NS-G limbs employ graphene technology to offer shorter and narrower string movement than any other limbs and provide the most efficient energy transfer. This performance creates better arrow grouping with forgiveness.

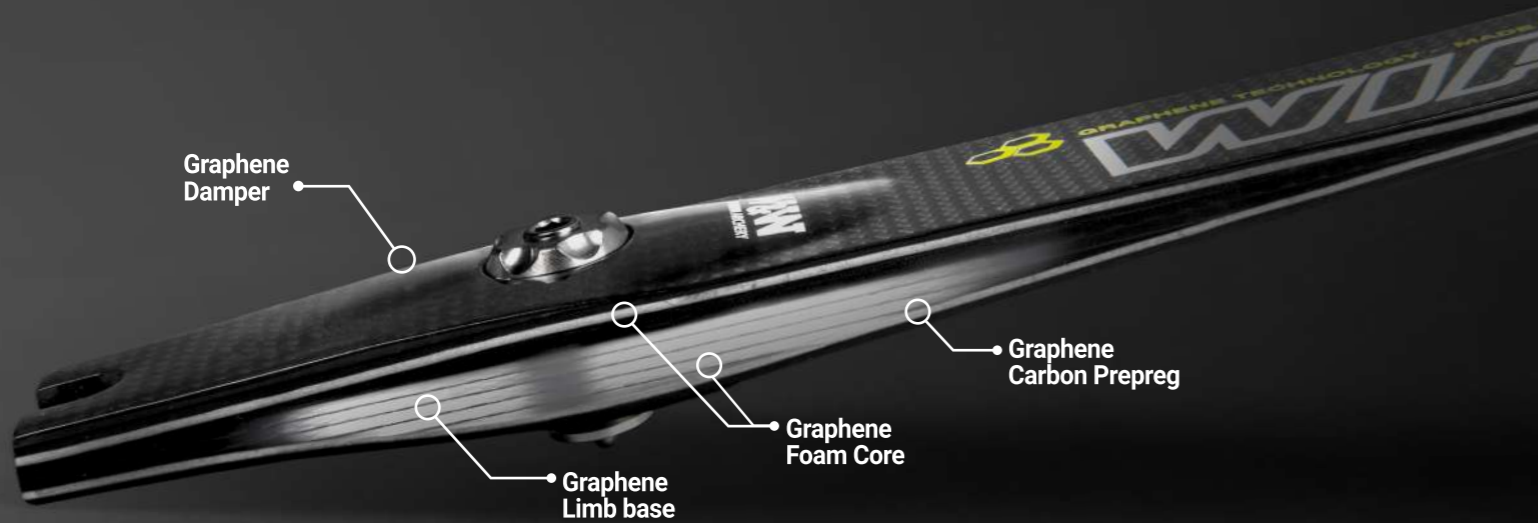
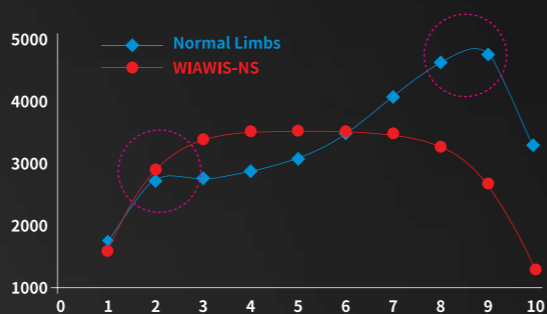
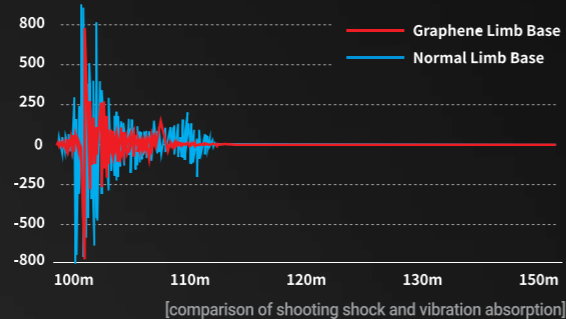

NS-G FOAM

The NS-G is very first limb in the world that uses innovative graphene materials for archery equipment.

It also adds a function that minimizes the impact that occurs when shooting in the bottom core part of the limbs. It minimizes bow torque that directly affects the arrow light.

Softer, but more advanced competition limbs that used graphene on foam cores to ensure that the arrows don't lose speed and light stability.

TECHNICAL SPECIFICATIONS

LENGTH	Short, Medium, Long
WEIGHT	28 to 48 lbs (2 lbs increment)
MATERIAL	Graphene Foam Core & Graphene Limb base / High Modulus Carbon

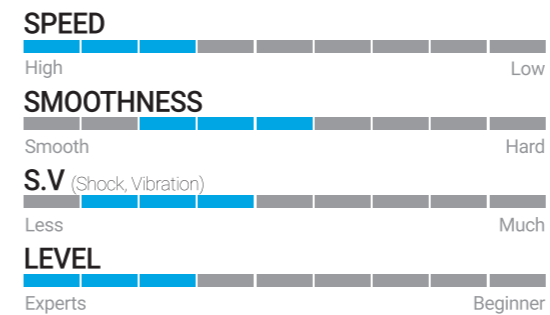

NS-G WOOD

NS-G WOOD enables stable drawing and sophisticated shooting, which improves shooting accuracy and arrow grouping.

TECHNICAL SPECIFICATIONS

LENGTH	Short, Medium, Long
WEIGHT	28 to 48 lbs (2 lbs increment)
MATERIAL	Wood Core & Graphene Limb base / High Modulus Carbon

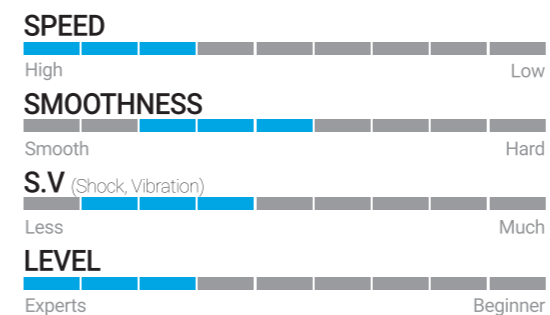

CX7 FOAM

Made of INNO EX POWER's equivalent materials, CX7 is a limb that enables you to feel WIN&WIN's technology more easily with cost effectiveness.

CX7 limb is an introductory limb that lets you feel the difference about high-end archery equipment.

TECHNICAL SPECIFICATIONS

LENGTH	Short, Medium, Long
WEIGHT	28 to 48 lbs (2 lbs increment)
MATERIAL	Nano Foam Core / High Modulus Carbon
FINISH	Matt

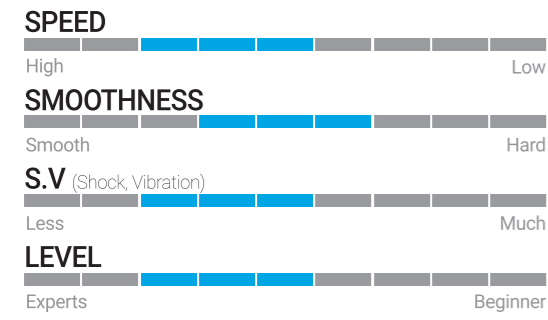

CX7 WOOD

TECHNICAL SPECIFICATIONS

LENGTH	Short, Medium, Long
WEIGHT	28 to 48 lbs (2 lbs increment)
MATERIAL	Wood Core & Graphene Limb base / High Modulus Carbon
FINISH	Matt



WINEX

The WINEX limb has been continuously developed with the WIN&WIN's limb manufacturing process that is improved and refined over time based on WIN&WIN's traditional limb making technology.

TECHNICAL SPECIFICATIONS

LENGTH	Short, Medium, Long
WEIGHT	28 to 48 lbs (2 lbs increment)
MATERIAL	Royal Cross Carbon

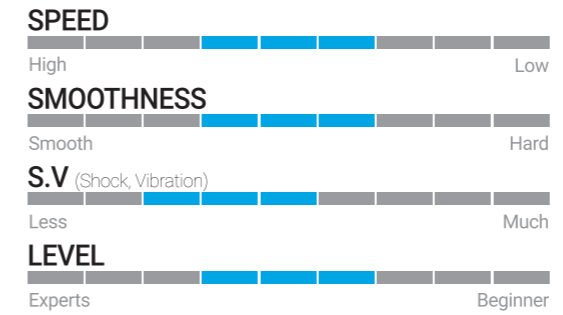

WIAWIS BOW SPECIFICATIONS

RISER TECHNICAL SPECIFICATIONS

RISER	LENGTH	MASS WEIGHT	TYPE	MATERIAL
META DX	25 inch	1380 g	RH/LH	Graphene / Nano Carbon
RADICAL PRO	25 inch	1300 g	RH/LH	Graphene / Nano Carbon
TFT-G	25 inch	1320 g	RH/LH	Graphene / Nano Carbon
INNO CXT	23 inch	1120 g	RH	Nano Carbon
	25 inch	1200 g	RH/LH	
	27 inch	1260 g	RH	
CX7	25 inch	1250 g	RH/LH	Carbon Composite
	25 inch	1360 g	RH/LH	
ATF-DX	25 inch	1360 g	RH/LH	Aluminum / CNC Machining
	27 inch	1430 g		
ATF-X	25 inch	1280 g	RH/LH	Aluminum / CNC Machining
	27 inch	1350 g		
WINEX	23 inch	1190 g	RH	Aluminum / CNC Machining
	25 inch	1250 g	RH/LH	Aluminum / CNC Machining

LIMBS TECHNICAL SPECIFICATIONS

LIMBS	LENGTH	TYPE	MATERIAL
MXT-XP FOAM CORE	Short, Medium, Long	28~48 lbs	Graphene Foam Core & Graphene Limb base / High Modulus Carbon
MXT-XP WOOD CORE	Short, Medium, Long	28~48 lbs	Wood Core & Graphene Limb base / High Modulus Carbon
NS-G FOAM CORE	Short, Medium, Long	28~48 lbs	Graphene Foam Core / High Modulus Carbon
NS-G WOOD CORE	Short, Medium, Long	28~48 lbs	Wood Core / High Modulus Carbon
CX7 FOAM CORE	Short, Medium, Long	28~48 lbs	Nano Foam Core / High Modulus Carbon
CX7 WOOD CORE	Short, Medium, Long	28~48 lbs	Wood Core / High Modulus Carbon
WINEX	Short, Medium, Long	28~48 lbs	FoamCore / Royal Cross Carbon

GRIP COMPATIBILITY

	1	4	5	6	7	CTK II	CTK III	CTK-H	8		
	Standard Plastic	Standard Wood	Standard Plastic	Standard Plastic	High Plastic	High Wood	Standard Plastic	CTK II Wood	CTK III Wood	CTK-H Wood	Standard Plastic
META DX	○	○	○	○	○	○	●	○	○	○	○
RADICAL PRO	○	○	○	○	○	○	●	○	○	○	○
TFT-G	○	○	○	○	○	○	●	○	○	○	○
INNO CXT, CXT LIGHT	○	○	○	○	○	○	●	○	○	○	○
CX7	○	○	○	○	○	○	●	○	○	○	○
ATF-DX	○	○	○	○	○	○	○	○	○	○	●
ATF-X	○	○	○	○	○	○	●	○	○	○	○
WINEX	○	○	○	○	○	○	●	○	○	○	○

※● = standard grip to be set in the factory / ○ = compatible

※ Wooden grip in same group from 1 to 6 is marked 'high' on the basis of standard grip at the factory.



LISA BARBELIN /FRANCE



2023 **WIAWIS ACCESSORIES**

- SIGHT
- STABILIZER
- UPPER STABILIZER
- DAMPER
- WEIGHT
- BOLT
- V-BAR
- CUSHION PLUNGER
- ARROW REST
- CLICKER
- FINGER TAB
- ARM GUARD
- BOW STAND
- BOW CASE
- STRETCH BAND

WS 700



GRAPHENE FOAM CORE

WS700 is WIN&WIN's brand new precision-machined competition sight, the evolution of the WS600 series. It has wheel tuners to accurately measure fine sight movements and a slide bar for convenient and smooth vertical adjustment. A unique bolt system securely locks the sight in place.

Graphene exclusive technology inside its carbon extension bar protects the WS700 from damaging vibration that travels through a bow when it is shot. It also keeps weight to a minimum and prevents torque during shooting.

TECHNICAL SPECIFICATIONS

TYPE	RH / LH
WEIGHT	207 g

The fruit of Nano Technology - Graphene Foam core

Graphene is an atomic-scale honeycomb lattice made of carbon atoms. Graphene thickness of 0.2 nanometers is over 200 times stronger than the strongest steel and has improved shock absorption qualities over CNT(Carbon Nano Tube). That's why we call it 'the fruit of Nano technology'. Graphene foam is solid open-cell foam made of single-layer sheets of graphene. The material properties and structure provide excellent tensile strength and approximately double the impact strength over present foam materials. The use of this material in Archery products has been solely developed by WIN&WIN.

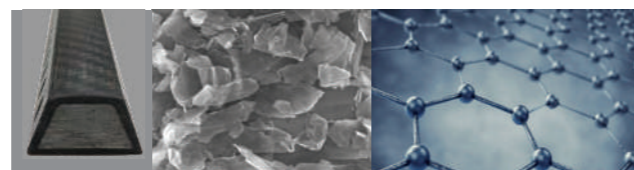

WS 600



NEVER COMPROMISE YOUR AIM

WS600 is WIN&WIN's precision-machined competition sight, trusted by some of the world's best archers. It has wheel tuners to accurately measure fine sight movements and a slide bar for convenient and smooth vertical adjustment.

A unique bolt system securely locks the sight in place. Foam inside its carbon extension bar protects the WS600 from damaging vibration that travels through a bow when it is shot. It also keeps weight to a minimum and prevents torque during shooting.

TECHNICAL SPECIFICATIONS

TYPE	RH / LH
WEIGHT	221 g



ACS-EL

The design of the ACS-EL stabilizer maximizes the performance by effectively minimizing bow torque, shock absorption and vibration characteristics



INCLUDED
 BOTTOM FLAT (45 g) FLAT (25 g) HEAD (45 g)
 S21 WEIGHT



ACS-EL EXTENDER



TECHNICAL SPECIFICATIONS

LONG ROD LENGTH	26 inches (165 g)	28 inches (168 g)
	30 inches (171 g)	32 inches (176 g)
SHORT ROD LENGTH	10 inches (74 g)	11 inches (77 g)
	12 inches (80 g)	14 inches (84 g)
	15 inches (86 g)	
EXTENDER LENGTH	2 inches (58 g)	4 inches (60 g)
	3 inches (55 g)	6 inches (70 g)
	5 inches (65 g)	

WIAWIS STABILIZER

Stabilizers require to be strong and rigid to suppress bow torque during shooting. They have been designed and manufactured to effectively reduce the impact and vibration generated during shooting.

The ACS-EL stabilizer uses high-tech materials such as graphene carbon to improve stiffness and stability.

The design is also maximized performance through WIAWIS's unique carbon pattern and tapered structure.

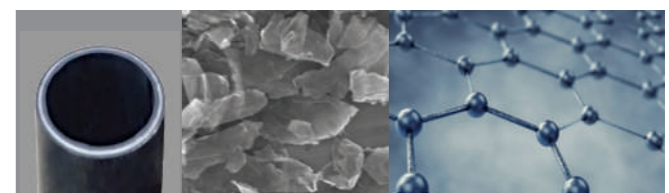

- high Modulus carbon application
- effective stiffness and tapered structure for better shock and vibration absorption
- optimized mass weight

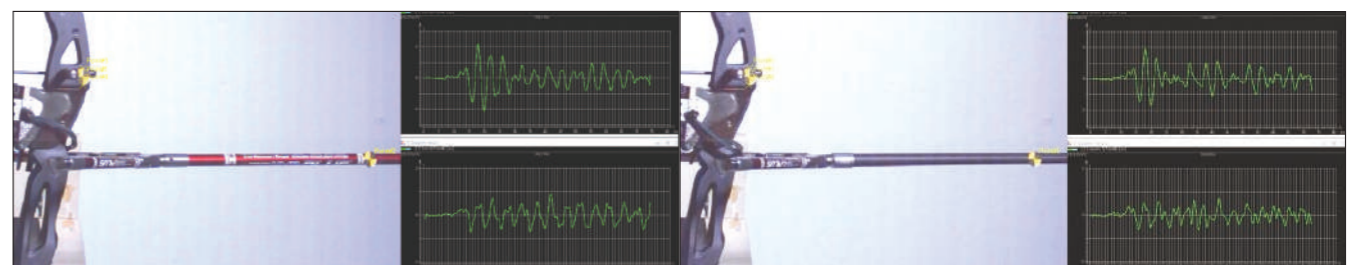

When using the WIAWIS ACS EL stabilizers on a bow, the riser movement becomes better balanced and more stable.

ACS 15

The ACS 15 is a 15 Ø diameter, thin but weighty stabilizer with excellent shock resistance, vibration reduction, and stability, which effectively reduces the vibration and impact of shooting and improves the feeling of the shot. It has been designed not only for recurve shooters, but also for the compound market.

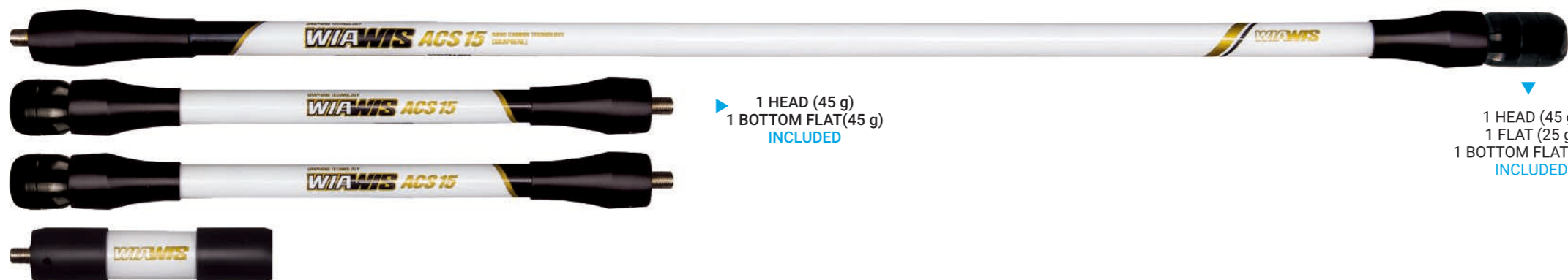

▶ 1 HEAD (45 g)
1 BOTTOM FLAT(45 g)
INCLUDED

▼ 1 HEAD (45 g)
1 FLAT (25 g)
1 BOTTOM FLAT(45 g)
INCLUDED

TECHNICAL SPECIFICATIONS

LONG ROD LENGTH	26 inches (200 g)	28 inches (210 g)
	30 inches (220 g)	32 inches (230 g)
SHORT ROD LENGTH	10 inches (109 g)	11 inches (112 g)
	12 inches (115 g)	14 inches (124 g)
	15 inches (125 g)	
EXTENDER LENGTH	3 inches (65 g)	4 inches (80 g)
	5 inches (90 g)	6 inches (100 g)

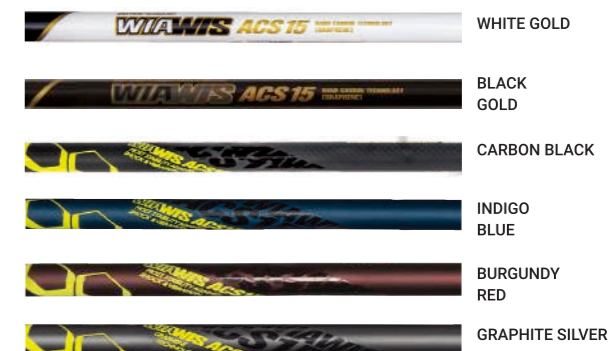

S21

S21 stabilizer uses the graphene carbon and tapered structures (21.0mm-17.5mm) to reduce the vibration caused by shooting more reliably. In addition, the stiffness is improved compared to HMC PLUS stabilizer, allowing compound archers to use it.



▶ 1 HEAD (45 g)
1 BOTTOM FLAT(45 g)
INCLUDED

▼ 1 HEAD (45 g)
1 FLAT (25 g)
1 BOTTOM FLAT(45 g)
INCLUDED

TECHNICAL SPECIFICATIONS

LONG ROD LENGTH	26 inches (140 g)	28 inches (150 g)
	30 inches (155 g)	32 inches (160 g)
SHORT ROD LENGTH	10 inches (85 g)	11 inches (90 g)
	12 inches (95 g)	14 inches (100 g)
	15 inches (105 g)	
EXTENDER LENGTH	3 inches (60 g)	4 inches (75 g)
	5 inches (85 g)	6 inches (90 g)



HMC PLUS

HMC PLUS stabilizer is a best-selling product over a long period of time at WIN AND WIN Co., Ltd. It is made of High Modulus carbon and the outside diameter is 18.5 mm straight (internal tapered) stabilizer, which can be used in all weather conditions regardless of the performance of men and women.



▶ 1 HEAD (45 g)
1 FLAT(45 g)
INCLUDED

▼ 1 HEAD (40 g)
2 FLATS (25 g)
INCLUDED

TECHNICAL SPECIFICATIONS

LONG ROD LENGTH	26 inches (111 g)	28 inches (116 g)
	30 inches (122 g)	
SHORT ROD LENGTH	10 inches (80 g)	11 inches (84 g)
	12 inches (89 g)	
EXTENDER LENGTH	3 inches (50 g)	4 inches (65 g)
	5 inches (75 g)	6 inches (80 g)



UPPER STABILIZER



ACS-ST CARBON UPPER STABILIZER

The ACS-ST CARBON UPPER STABILIZER has an increased carbon content of the carbon tube to reduce the impact of shooting more effectively. A stainless steel cap provides increased weight and strength to increase shooting feeling.

LENGTH	120 mm	WEIGHT	185 g
THREAD SIZE	5/16"-24		

COLORS



MATT BLACK MATT GOLD MATT SILVER RAINBOW

ACS-EL CARBON UPPER STABILIZER

The ACS-EL Carbon Upper Stabilizer's all-carbon core suppresses vibration and bow torque quickly at release along with a help of Multi Damper attached.

LENGTH	125 mm	WEIGHT	125 g
THREAD SIZE	5/16"-24		

COLORS



MATT BLACK MATT RED MATT BLUE RAINBOW

ACS CARBON UPPER STABILIZER

Carbon bar, multi damper and aluminum body-well-balanced in three parts help efficient vibration and bow torque control.

LENGTH	125 mm	WEIGHT	125 g
THREAD SIZE	5/16"-24		

COLORS



MATT BLACK MATT RED MATT BLUE GLOSSY RAINBOW GLOSSY GOLD GLOSSY SILVER

DAMPER



WIAWIS MULTI DAMPER

WIAWIS MULTI damper is designed to reduce vibration quickly caused by shocks during shooting and to reduce secondary vibrations after shooting from special material and strength of the damper.

It is also designed to be used with various types of bows such as up, long and short stabilizer and weight control dampers under the grip by using the screws of 1/4"-20 and 5/16"-24. The damper is available not only for recurve bow but also for compound bow.

LENGTH	38 mm	WEIGHT	48 g
COLORS	BLACK		



ACS DAMPER

After much research and development by the Win&Win team on the shape and length of vibration waves with stabilizers, Win&Win has released their WIAWIS ACS Damper. The ACS Damper is far superior in absorbing vibration.

LENGTH	50 mm	WEIGHT	33 g
THREAD SIZE	1/4"-20	COLORS	BLACK

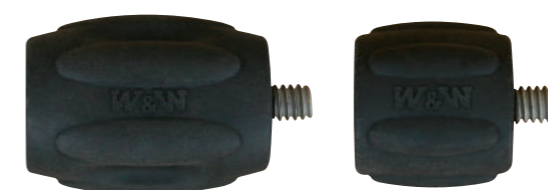

BW DAMPER

BW SHORT DAMPER

BW&BW SHORT DAMPER

BW dampers are made from an absorbent rubber material that nearly eliminates vibration during shooting and controls poor movement in equipment after the shot.

LENGTH	BWD : 40 mm	BWD SHORT : 25 mm
WEIGHT	BWD : 45.5 g	BWD SHORT : 32.5 g
THREAD SIZE	1/4"-20	COLORS BLACK



MATHEWS® HARMONIC DAMPER

MATHEWS® EHS™ HARMONIC DAMPER

MATHEWS® HARMONIC DAMPER

WEIGHT	10 g	COLORS	BLACK
--------	------	--------	-------

MATHEWS® EHS™ HARMONIC DAMPER

WEIGHT	32 g	COLORS	BLACK
--------	------	--------	-------

WEIGHT

DISC COLOR WEIGHT

WIAWIS DISC COLOR weight products are made in three weights and four colors. It was designed to allow archers to set their own weight and color freely.

In order to apply both 1 / 4-20 and 5 / 16-24 threaded parts to the bows, Three types of screws are included below

WEIGHT - 20 g / 40 g / 60 g

*included screws

- 40mm screw 5/16-24 
- 23mm screw 5/16-24  1/4-20
- 20mm screw 5/16-24 

WEIGHT



COLORS



COLOR WEIGHTS

WEIGHT - Head 40 g / Flat 23 g



COLORS



WIN WEIGHT(HMC PLUS)

WEIGHT - Head 40 g / Flat 25 g



S21 WEIGHT

WEIGHT - Head 45 g / Flat 25 g / Bottom 45 g



CAPS



META CAP

META CAP is a product designed to make the META DX riser lighter when the user wants it. You can remove either the assembled MATHEWS® EHS™ HARMONIC DAMPERS or MATHEWS® HARMONIC DAMPER on its own, or both if required. You can then replace them by inserting the META CAPs into the empty holes.

SIZE	32 ø (mm)	COLORS	BLACK
WEIGHT	9 g	MATERIAL	SILICONE

BOLTS

TILLER ADJUSTMENT BOLT

All tiller bolts are 13mm diameter and are compatible with any type of WIAWIS risers.

COLOR ALUMINUM TILLER BOLT



COLOR STAINLESS STEEL TILLER BOLT



TFT-G ALUMINUM TILLER BOLT



META-DX STAINLESS STEEL TILLER BOLT (META-DX, RADICAL PRO, ATF-X, ATF-DX)



CXT STAINLESS TILLER BOLT



LIMB BOLT

WEIGHT - 2g

(*original stainless steel limb bolt weighs 6grams)

COLORS



V-BAR

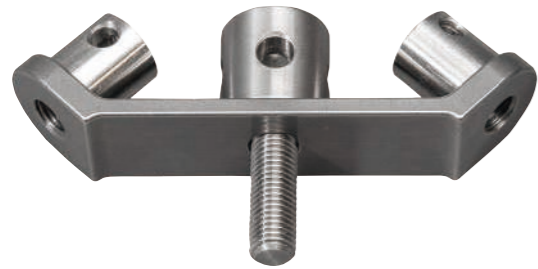

WIAWIS SUS V-BAR

This is a new concept of V-Bar made from strong stainless steel with enhanced design. It has a reduced mass compared to a standard V-Bar and is designed to quickly transfer the shooting shock/vibration through into the stabilization. It helps to make the shooting feel more stable.

WEIGHT	115 g	COLORS	Satin
--------	-------	--------	-------

☒ TWO STRAIGHT ANGLES - 40, 45 degrees

CUSHION PLUNGER / REST

MIGHTY CUSHION PLUNGER

MIGHTY cushion plunger is designed to enhance the concentration in a optimized size, and the aluminum material offers luxurious finish and gentle button action.

MATERIAL	Stainless steel	WEIGHT	43 g
THREAD SIZE	5/16"-24	COLORS	Black, Silver
ADJUSTABLE LENGTH	min 24.0 mm – max 29.0 mm (29 mm pressure point) min 17.5 mm – max 24.0 mm (24 mm pressure point)		

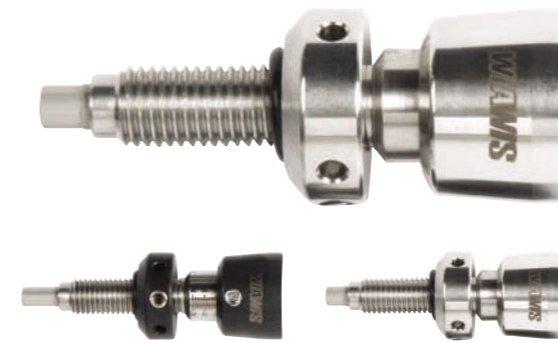

WMR200 ARROW REST

WIN&WIN's recurve arrow rest uses a flipper-style arm to improve accuracy and ensure smooth shooting. It incorporates a bearing that tightens groups on the target while providing superb clearance. The arm is stiff and stable, minimizing the vertical movement that interferes with clean arrow flight.

TYPE	RH / LH	COLORS	Black, Silver
------	---------	--------	---------------



WIAWIS CX-AD V-BAR

The adjustable carbon V-Bar allows the elevation angle of the short stabilizers by movement up and down. It is made from carbon fiber which makes it lighter than any other adjustable V-Bar. The vibration absorption properties are excellent which will enhance the archers concentration and feeling during shooting. It offers the adjustability to fix the short rods in any configuration possible to suit individual archer personal feeling requirements.

WEIGHT	198 g	COLORS	Carbon Matt or Carbon Glossy
--------	-------	--------	------------------------------

Carbon Matt

Carbon Glossy



WIAWIS S21 V-BAR

Though most shock that occurs when shooting is absorbed by a stabilizer and V-Bar, some vibration returns to the riser and makes consistent accuracy difficult. WIAWIS S21 V-Bar is designed to absorb shock more efficiently, and increase shooting consistency by minimizing the vibration. Create your perfect stabilization system!

WEIGHT	120 g	COLORS	Carbon Matt or Carbon Glossy
--------	-------	--------	------------------------------

☒ FOUR STRAIGHT ANGLES - 35, 40, 45 & 42 degrees

Carbon Matt

Carbon Glossy



WIAWIS CX2 V-BAR

WIAWIS CX2 V-Bar is designed to absorb shock, and increase shooting consistency by minimizing the vibration that returns back into the riser.

WEIGHT	86 g	COLORS	Carbon Matt
--------	------	--------	-------------

☒ THREE STRAIGHT ANGLES - 35, 40, 45 degrees

CLICKER



ARC CLICKER

In existing ACS clickers, we reinforced the blade to have an arch shape allowing an arrow to be placed in the clicker without using a finger.

SIZES	6-32, 4-40 or M4	MATERIAL	Carbon
STRENGTH	SOFT / HARD		

COLORS



ACS CLICKER

The sleekly-shaped plate with a metal cap gives you a crystal-clear 'click' sound, with easier and more precise adjustment than before.

SIZES	6-32, 4-40 or M4	MATERIAL	Carbon
STRENGTH	SOFT / HARD		

COLORS



COLOR CLICKER

As precisely machined stainless steel clicker, it provides accurate and stable timing when aiming. In addition, the tightening part of the clicker is ergonomically designed by allowing easy adjustment of the upper and lower and the front and the rear positions of the clicker by simple locking and loosening .

SIZES	6-32, 4-40 or M4	MATERIAL	Stainless steel
BLADE COLORS	Black, Rainbow, Gold, Silver		
CAP&WHEEL COLORS	Black or Clear		

FINGER TAB

EZ FINGER TAB

The EZ finger tab is designed with an adjustable plate to perfectly fit your palm and allow for comfortable and natural hooking. The plate can be precisely adjusted to fit your hand by moving the plate in three planes :

up and down, front and back, and diagonally. The small size of the tab takes away obstructions. The tab is made from reliable, high-quality genuine Cordovan leather.

TYPE	RH/LH	SIZE	XSmall, Small, Medium, Large
------	-------	------	------------------------------

CORDOVAN LEATHER SOLD SEPARATELY



EZ R FINGER TAB

The round design of the EZ R Tab and unique sliding adjustments allow for comfortable thumb positioning and natural hooking. The unique plate positioning brings dynamic control over the WIAWIS EZ R finger tab. It is possible to control factors such as hand shape, the force being transmitted through the hand, and sensation of the shot. The plate that supports the little finger can be micro-adjusted and is also detachable. The tab is made from reliable, high-quality genuine Cordovan leather.

TYPE	RH/LH	SIZE	XSmall, Small, Medium, Large
------	-------	------	------------------------------

CORDOVAN LEATHER SOLD SEPARATELY



360 CORDOVAN FINGER TAB

360 Cordovan finger tab has long been loved by many archers for many year. The 360 finger tab is designed using cordovan leather, exchangeable with archers' comfort in mind.

TYPE	RH/LH	SIZE	Small, Medium, Large
------	-------	------	----------------------

CORDOVAN LEATHER SOLD SEPARATELY



ACCESSORIES

FINNO CHEST GUARD

Ergonomically designed to sit securely and consistently on the shoulder and around the chest shot after shot, FINNO Chest Guard was designed by archers for archers!

TYPE	RH / LH	SIZE	Small, Medium, Large
------	---------	------	----------------------

COLORS



A-3 QUIVER

The total weight is dropped significantly and a cushioned belt provides a comfortable fit. Magnets at the bottom of the quiver make arrow carrying easy and multiple pockets allow you to carry all kinds of accessories.

TYPE	RH / LH
BELT SIZE	Adjustable from 23 to 49 inches

*THREE ARROW TUBES

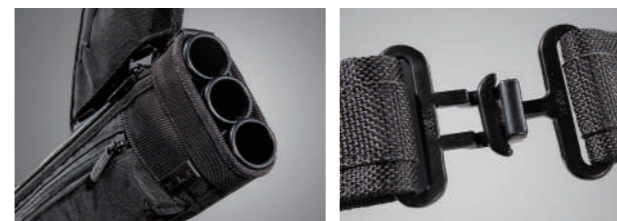

CARBON BOW STAND

Unlike existing carbon bow stands, the string rest of the WIAWIS CARBON BOW STAND is designed to minimize any damage to the string, enhancing the durability of the stand. The string rest can be freely adjusted up and down to facilitate individual bow requirements. The head of the stand is designed to provide a sense of unity with the grip of the riser, and is made from a silicon material for more stable positioning.

Base fixing pins are provided in two different lengths to allow tailoring to the shooting field conditions. This give versatility to allow a solid/stable bow stand to protect your equipment.



AT-100 ARM GUARD

AT-100 Arm Guard has a skeleton-like structure with all the unnecessary parts cut out, making it extremely light and comfortable to wear. Its smooth outer surface creates less friction when impacted by the string.

COLORS



TY MULTI BOW STAND

Suitable for indoor and outdoor use, the TY Multi Bow Stand is solidly built and a reliable bow support in all conditions. It is light yet strong and durable, its flip-lock legs fold up for easy storage and comes with two types of cradle head.

Stable in any conditions with more firmly designed rest.



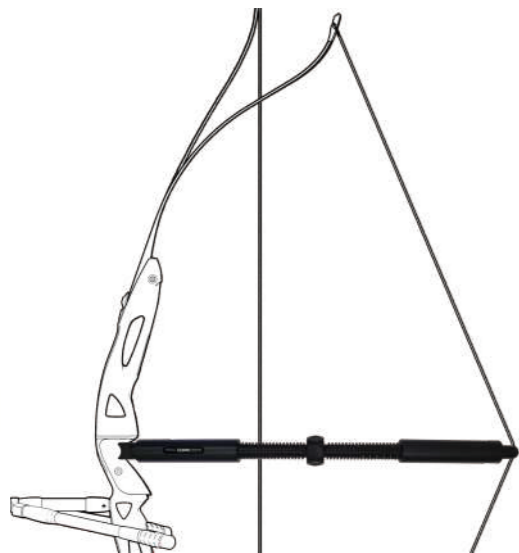

Check the center-shot at set-up and full draw of the bow

TW-BRACE

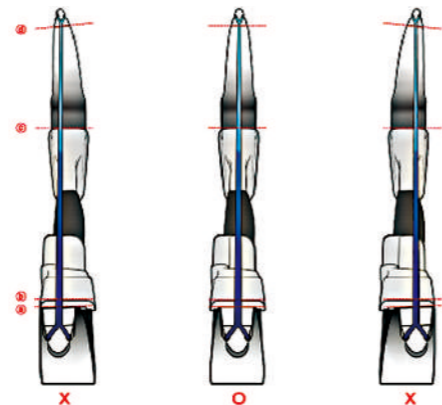

The best way to check the alignment of the limbs along with your handle is when the bow is put at full draw. We have created the best tool to achieve it! The WIAWIS TW-BRACE allows a safe setup of your bow.

CAUTION :
Do not draw over 29"(marked red dot) or the TW-BRACE could collapse.

WIAWIS SPANNER WRENCH

This tool is designed to help effectively tighten or loosen the WIAWIS stabilizers. 5mm and 4mm Allen wrenches are included in this spanner, replacing your existing tools. Simply carry this one tool for all your stabilizer needs. WIAWIS SPANNER Wrench can also be used for non-WIN&WIN products as long as there is a hole in the end-cap of the stabilizer.



ARROW PULLER

The solid gripping surface on WIAWIS arrow puller makes retrieving arrows from the target safe and easy. It fits comfortably in the hand, includes a keyring for attachment to a belt or pack. Shaped like a cat!



SCAPOWER STRETCH BAND

Used as an exercise tool, the SCAPOWER Stretch Band will increase an archer's pulling weight, build up muscle and develop firmness in the shoulder.

It can also be used to improve posture and technique. Daily practice is recommended : 10 minutes at a time with at least a 2 or 3 minute break. It does not take long to see improvement in shot placement, draw process and balance in the bow shoulder. Try it for yourself!



BALL STRETCH BAND

Used as an exercise tool, WIAWIS BALL Stretch Band will increase archer's strength & flexibility. The archer's posture and technique will be improved with this.

COLORS Black, Red, Blue, Yellow



ABS BOW CASE

Protecting archery equipment is essential, and that is why the ABS Bowcase has such a solid outer shell. The smart design includes an extendable trolley handle, but does not sacrifice space for its impressive durability. Inside, there is plenty of room to store and organize a variety of archery gear.

SIZE	INNER - 830x330x205 (mm) OUTER - 878x348x219 (mm)
COLORS	Black, Silver





2023 **WIAWIS** **APPAREL**

- T-SHIRT
- CAPS
- BEANIE
- UMBRELLA
- TUMBLER
- SHOE COVER
- CLOCK
- CHAIR

T-SHIRTS



2022 OFFICIAL ARCHER SHIRT

COLOR	PURPLE
SIZE	Small, Medium, Large, XLarge, XXLarge



2022 OFFICIAL ARCHER SHIRT

COLOR	BLUE
SIZE	Small, Medium, Large, XLarge, XXLarge



2016 OFFICIAL ARCHER SHIRT

COLOR	YELLOW
SIZE	Small, Medium, Large, XLarge, XXLarge



2017 OFFICIAL ARCHER SHIRT

COLOR	PINK
SIZE	Small, Medium, Large, XLarge, XXLarge



2015 OFFICIAL ARCHER SHIRT

COLOR	RED&BLUE
SIZE	Small, Medium, Large, XLarge, XXLarge



2016 OFFICIAL ARCHER SHIRT

COLOR	SKY BLUE
SIZE	Small, Medium, Large, XLarge, XXLarge



2017 OFFICIAL ARCHER SHIRT

COLOR	BLACK PINK
SIZE	Small, Medium, Large, XLarge, XXLarge



2018 WIAWIS T-SHIRT

COLOR	BLACK
SIZE	Small, Medium, Large, XLarge, XXLarge

CAPS



CAP 1

COLOR WHITE



CAP 2

COLOR GRAY



CAP 7

SIZE S(54 cm), L(58 cm)

COLOR NAVY



FOLDING CAP

COLOR BLUE



CAP 3

COLOR BLACK



CAP 4

COLOR SAND BEIGE



FOLDING CAP

COLOR BLACK RED



FOLDING CAP

COLOR BLACK YELLOW



CAP 5

COLOR NAVY



CAP 6

COLOR GRAY



BEANIE 1

COLOR BLACK



BEANIE 2

COLOR NAVY

ETC ACCS

WIAWIS UMBRELLA



UMBRELLA

TELESCOPIC UMBRELLA

WIAWIS TUMBLER



SIZE: 500ml



SHOE COVER



	S	M	L	XL
RECOMMENDED SHOE SIZE	190~210 mm	210~245 mm	250~280 mm	280~320 mm
COLOR	BLACK			



WALL CLOCK

SIZE 337x337 mm



WIAWIS CHAIR

SIZE 580x530x340 mm

TECHNOLOGY

WIN&WIN equipment is created by the best
and checked by the best.



GRAPHENE NANO CARBON TECHNOLOGY

Graphene is an atomic-scale honeycomb lattice made of carbon atoms. Graphene thickness of 0.2 nanometers is over 200 times stronger than the strongest steel and has improved shock absorption qualities over CNT (Carbon Nano Tube). The material properties and structure provide excellent tensile strength and approximately double the impact strength over present foam materials. The use of this material in Archery products has been solely developed by WIN&WIN.



WIN&WIN CARBON TECHNOLOGY

High-tech engineering creates the best carbon material mixture for WIN&WIN bows, improving product quality and gaining athletes' confidence.



CARBON NANOTUBE TECHNOLOGY

Carbon nanotube and graphite nanofiber are true 21st century materials. They can be made as small as / 10,000th of a human hair, and have superior mechanical, chemical, physical and magnetic properties. Scientists believe nano-materials are the building blocks for the next generation of engineering.



WIN&WIN BOW TECHNOLOGY

Archery specialists and composite material professionals work together at our high-tech facilities to develop each WIN&WIN product. With the right balance of expertise and passion, they deliver the science of archery every single day.



WEIGHT BALANCE SYSTEM

The Weight Balance System is installed in the middle of the riser front end. It moves the center of gravity towards the front side, giving a more comfortable shooting feel and reducing unnecessary movement.



STRAIN BALANCE SYSTEM

A balance system concentrated on the top of the limbs distributes strain energy to the overall limb. It helps to minimize unnecessary limb movement and keeps your shooting smooth and stable.



THE SCIENCE OF SHOOTING FEELING

WIN&WIN products are designed with the archer in mind. Every innovative technology we use is part of the science of shooting feeling.



ABSORB VIBRATION SYSTEM

WIN&WIN's revolutionary new stabilization system specifically addresses the issue of vibration travelling back into the bow. The new ACS-EL stabiliser's unique design absorbs shock, improves dampening and controls torque during shooting.



HIGH TECH FOAM CARBON

Traditional limbs are coated in glass fiber to protect the carbon but it reduces arrow speed because it is so heavy. WIN&WIN uses a 45-degree carbon system that effectively protects the limb, increases shooting stability and reinforces against twisting.



3Ss: SPEED, STABILITY & SMOOTHNESS

Limbs are evaluated by three measurements : arrow speed, stability and smoothness. We research, design and develop all our bows based on these key factors. This makes sure that archers love each and every WIN&WIN product.



TORQUE FREE

Torque as the bow twists in an archer's grip when they release affects arrow flight directly, and will lessen accuracy. Reducing torque within the 0.03 seconds after an arrow is released dramatically improves consistency. WIN&WIN's TFS device absorbs shock and vibration on shooting, minimizes torque and increases accuracy.



CROSS CARBON LIMB TECHNOLOGY

A carbon fabric exclusively produced by WIN&WIN reinforces limbs against twisting and raises their elastic modulus. That means the limbs are stiffer, more stable and produce higher arrow speeds.



THE SCIENCE OF STRING FOLLOW-THROUGH

WIN&WIN engineers know that bow performance is measured on accuracy, stability, arrow speed and how smooth it feels at the moment it is shot. The last is the most important, and the string follow-through or string reaction on release is a major indicator of whether a bow feels good.



TOWER EFFECT

WIN&WIN's barrelled bottom (thicker and wider) design creates an innovative tower effect. This absorbs shock during the shot and increases accuracy by removing unnecessary movement in the bow.



EXTREME DURABILITY

WIN&WIN bows are made to a superior standard. During development each design must survive a 100,000-repetition durability test.



IDEAL GRIP

The WIN&WIN ideal grip is moulded to accept the joint of each finger, making drawing and aiming easier and minimizing torque during shooting.



CENTER SHOT ADJUSTMENT SYSTEM

With WIN&WIN's unique system, limb and riser alignment can be adjusted without unstringing the bow. We also designed a highly-specialized washer that prevents limb bolts from randomly coming loose.



ALUMINIUM FORGING TECHNOLOGY

Our hot forging system enhances the useful properties of all WIN&WIN aluminum products, like tensile strength and hardness.



T6 HEAT TREATMENT

T6 heat treatment raises the tensile strength and elastic modulus of WIN&WIN aluminum risers, making them resilient to intense shock.



AN SAN / KOREA



FELIX WIESER / GERMANY



KIM JE DEOK / KOREA



SHANA MD RUMAN / BANGLADESH



THOMAS STANWOOD / USA



TAKAHARU FURUKAWA / JAPAN



MARCUS D'ALMEIDA / BRAZIL



JARNO DE SMEDT / BELGIUM



AGU UTANO / JAPAN



RIAU SALSABILLA / INDONESIA



PENNY HEALEY / GREAT BRITAIN



FEDERICO MUSOLESI / ITALY



RYAN TYACK / AUSTRALIA



LISA BARBELIN / FRANCE



DENG YU-CHENG / CHINESE TAIPEI



YAMAUCHI AZUSA / JAPAN



LOUISA PIPER / GREAT BRITAIN



WEI CHUN HENG / CHINESE TAIPEI



MORITZ WIESER / GERMANY



WANG DA PENG / CHINA



KHAIRUL ANUAR MOHAMAD / MALAYSIA

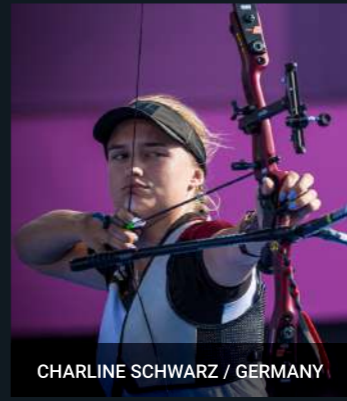

CHARLINE SCHWARZ / GERMANY



JAYANTA TALUKDAR / INDIA



LEI CHIEN-YING / CHINESE TAIPEI



AN QI XUAN / CHINA



PRAVIN RAMESH JADHAV / INDIA



PATRICK HUSTON / GREAT BRITAIN



LUCILLA BOARI / ITALY



ANKITA BHAKAT / INDIA



KANG CHAE YOUNG / KOREA



ALEX WISE / GREAT BRITAIN



CHIARA REBAGLIATI / ITALY



AIDA ROMAN / MEXICO



GIJS BROEKSMAS / NETHERLANDS



OLEKSII HUNBIN / UKRAINE



ALEN REMAR / CROATIA



BRIAN MAXWELL / CANADA



NAKAMURA MIKI / JAPAN



PENG CHIA-MAO / CHINESE TAIPEI



JAMES WOODGATE / GREAT BRITAIN

#WIAWIS
#THE WAY TO VICTORY



ACCREDITED
MSCB-113



WIN&WIN KOREA

19, Donghanggongdan-gil, Yangseong-myeon,

Anseong-si, Gyeonggi-do, 17502, KOREA

T +82 31 671 0894 F +82 31 671 0895

E win@wiawis.com

www.wiawis.com | www.win-archery.com

Find us on Facebook : Win&Win Archery · Follow us on Twitter : [wwarchery](https://twitter.com/wwarchery)

Follow us on Pinterest : [wwarchery](https://www.pinterest.com/wwarchery) · Follow us on Instagram : [winarchery](https://www.instagram.com/winarchery)