

www

LEVELVEN

T

A

R

G

E

T

S

.hu



Full of

IDEAS

2016 - 2017





### FULL OF IDEAS

We started with 3D targets in 2003. After 3 years of experience 2006 we started producing EP (Easy Pull) material. 3D targets and inserts inserted in polyfoam targets for target and field archery. The inserts can be adjusted according to the different rules and all other needs our customers may have. Our products are used by clubs and associations that wants to have long lasting targets but also on the highest level competitions like World Cups and World Championships. During the development, we experimented with materials that are flexible, resistant against physical load, but at the same time don't damage the arrows. During our researches, we concluded that due to the mode of usage, it is not one, but a combination of materials that must be used to satisfy all needs. We constantly work on developing new materials and products and making existing products better and more price worthy. We strive every minute to live and act according to our slogan: „Full of ideas”, this is best for our customer.



2002  
Founded ELEVEN

2003  
3D Targets

2003  
Developed EP

2005  
Buttress from polifoam

2006  
EP inserts in buttress  
EP inserts in 3D targets

2007  
EP multitarget

2008  
Modular buttress system

2009



# NEWS



## HOLE IN



## HOLE IN ONE!

### NEW

We use material where it is needed, you save money without making compromises. It looks the same, lasts as long, feels the same but costs less.

Sometimes less is more...



2010

2011

2012

2013

The WALL netting

2014

Developed ECO  
EPRO

2014

Fun archery products  
Elevelen+ butts

2015

Elevelen+ Slim

2016

Hole In technology



# 3D TARGETS



## ≡5 Rabbit

30x51x22 cm



## ≡27 Small Piggie

51x30x22 cm



<b>LEVEN</b>	
OTHER MANUFACTURER'S SIMILAR TARGETS	



## ≡49 Nutria

48x21x26 cm



<b>LEVEN</b>	
OTHER MANUFACTURER'S SIMILAR TARGETS	



## ≡36 Hare

## ≡36A Arctic Hare

20x40x22 cm



<b>LEVEN</b>	
OTHER MANUFACTURER'S SIMILAR TARGETS	





**≡37 Falcon**  
18x48x20 cm

100% **≡P**  
GROUP 4



**≡34 Pheasant**  
69x15x39 cm

100% **≡P**  
GROUP 4

<b>LEVEN</b>					
OTHER MANUFACTURER'S SIMILAR TARGETS					



**≡7 Owl**  
22x52x20 cm

100% **≡P**  
GROUP 4

**≡50 Whistler**  
21x21x56 cm

100% **≡P**  
GROUP 4 **NEW**

<b>LEVEN</b>					
OTHER MANUFACTURER'S SIMILAR TARGETS					



**≡26 Turkey**  
30x66x32 cm

100% **≡P**  
GROUP 4



**Peak performance - ≡P material**

- The material is **SELF-HEALING** able to take thousand of shots without any pass through
- In average they last 3,7 times longer
- The arrow pull is an average 53% easier
- Our **≡P** targets are in average 26% cheaper



Recommended for rainy conditions



According to the most 3D Rules



Durability



Price-Value Ratio



Arrow Pulling



Weight



Size



3D TARGETS



≡56 Varanus  
50x23x13 cm

NEW 100% EPi GROUP 4



≡39 Carp  
68x18x15 cm

100% EPi GROUP 4

≡22 Crocodile  
112x33x28 cm

100% EPi GROUP 4



≡32 Goose  
59x21x52 cm

100% EPi GROUP 4



**≡41 Marten**  
17x39x18 cm



**≡33 Duck**  
41x23x18 cm



**≡2 Badger**  
46x66x26 cm



**≡40 Otter**  
60x30x26 cm



**≡1 Fox**  
**≡1A Arctic Fox**  
39x54x25 cm



<b>LEVEN</b>					
OTHER MANUFACTURER'S SIMILAR TARGETS					



Recommended for rainy conditions



According to the most 3D Rules



Durability



Price-Value Ratio



Arrow Pulling



Weight



Size



**3D TARGETS**



**≡14A Cougar**  
**≡14 Black Panther**  
95x58x30 cm



**≡42 Wolverine**  
90x55x25 cm



**≡6 Wolf**  
95x58x23 cm



**≡47 Bedded Boar**  
95x40x30 cm





**NEW**



**≡52 Bubo Owl**  
70x27x35 cm

100% **EPi** **GROUP 3**

<b>LEVEN</b>					
OTHER MANUFACTURER'S SIMILAR TARGETS					



**≡57 Shark**  
145x50x40 cm

100% **EPi** **GROUP 3** **HOLE IN**



**≡48 Blackcock**  
65x28x50 cm

100% **EPi** **GROUP 3**

<b>LEVEN</b>					
OTHER MANUFACTURER'S SIMILAR TARGETS					



Recommended for rainy conditions



According to the most 3D Rules



Durability



Price-Value Ratio



Arrow Pulling



Weight



Size



**3D TARGETS**



**≡3 Pecari**

78x56x27 cm



**≡13 Bedded Deer**

82x45x27 cm

≡13H The horns are sold separately!



**≡13A Bedded Deer (dark)**

82x45x27 cm

≡13H The horns are sold separately!



**≡11 Deer**

109x118x24 cm

≡13H The horns are sold separately!



**≡11A Deer (dark)**

109x118x24 cm

≡13H The horns are sold separately!







### ≡46 Leaping deer

115x100x25 cm

≡46H The horns are sold separately!



<b>LEVEN</b>					
OTHER MANUFACTURER'S SIMILAR TARGETS					



### ≡30 Fallow Deer

125x87x30 cm

≡30H The horns are sold separately!



### ≡55 Lynx

67x70x24 cm



<b>LEVEN</b>					
OTHER MANUFACTURER'S SIMILAR TARGETS					



Recommended for rainy conditions



According to the most 3D Rules



Durability



Price-Value Ratio



Arrow Pulling



Weight



Size



**3D TARGETS**



**≡21 Wild Boar Medium**  
95x60x30 cm

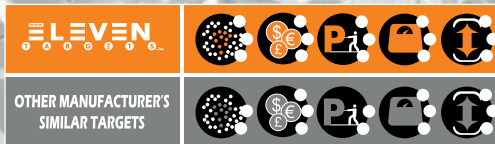

**≡29 Sitting Wolf**  
45x85x28 cm



**≡38 Turtle**  
54x100x44 cm





### ≡44 Chamois

100x61x25 cm



### ≡43 Ibex

110x95x25 cm



<b>LEVEN</b>					
OTHER MANUFACTURER'S SIMILAR TARGETS					



### ≡12 Sheep

103x112x25 cm



<b>LEVEN</b>					
OTHER MANUFACTURER'S SIMILAR TARGETS					



Recommended for rainy conditions



According to the most 3D Rules



Durability



Price-Value Ratio



Arrow Pulling



Weight



Size



## 3D TARGETS



**≡44 ≡Ik**

**200x147x35 cm**

≡44H The horns are sold separately!



**LEVEN**



OTHER MANUFACTURER'S  
SIMILAR TARGETS



**≡15 Stag**

**170x154x42 cm**

≡15H The horns are sold separately!



**≡31 Mountain Goat**

**125x96x34 cm**



**NEW** New Products

**100%** Targets made out of 100% EasyPull Material

**HOLE IN** HOLE IN technology

**3D EP** 3D targets with removable EP inserts

**EP** Easy Pull Material insert can be ordered separately

**ECO** ECO solutions

**+** Modular solutions



**≡53 Wolf**  
w insert  
115x73x25 cm

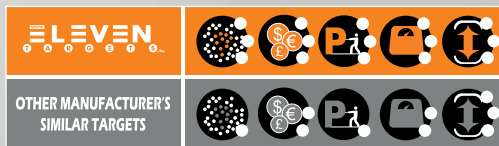

**≡8 Wild Boar**  
123x67x37 cm



**≡35 Tiger**  
173x89x36 cm



**≡35A Lion**  
173x89x36 cm



Recommended for rainy conditions



According to the most 3D Rules



Durability



Price-Value Ratio



Arrow Pulling



Weight



Size



**3D TARGETS**



**≡54 Bear with insert**  
**≡54A Dark Bear with insert**  
**≡54P Polar Bear with insert**  
 119x84x28 cm

**≡20 Standing Bear**  
 58x207x55 cm  
**≡20P Standing Polar Bear**  
 58x207x55 cm

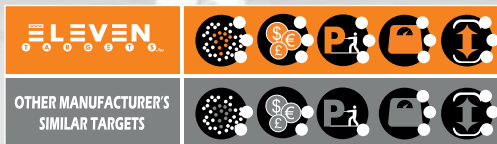





**NEW** **HOLE IN**

Sometimes less is more. In our efforts to create more value to our customers a solution emerged that is new on the 3D market. As foam material is really expensive if you want to reduce price there are two ways to go. Reduce the weight of material meaning less material put in the targets, which is the path others walk resulting poorer quality targets. We do not want to make compromises on the well-known extraordinary quality of  $\Xi$ even targets so we looked at where it is not necessary to have material at all, as cheapest material on earth at the moment is air being free of charge. If we have a hole where targets are not used to much but we still have enough foam to stop just in case any arrow is shot there was the solution. HOLE IN was born. Same quality, same feeling, same durability to a reduced price. We are proud to present the HOLE IN series.



Recommended for rainy conditions



According to the most 3D Rules



Durability



Price-Value Ratio



Arrow Pulling



Weight



Size



## 3D ACCESSORIES

### Backstop series

- E4a 80x80x10 cm
- E4b 80x110x10 cm
- E4c 100x100x10 cm
- E4d 130x130x10 cm
- E4e 80x200x10 cm
- E4f 150x200x10 cm



### EPRO series for practice or as backstop for maximum protection

- EPRO60 60x60x7 cm
- EPRO80 80x80x7 cm
- EPRO100 100x100x7 cm
- EPRO125 125x125x7 cm



### E3DST Premium Stand for 3D

For all ELEVEN 3D targets... From the smallest to the largest. Easy installing and stable position.



The Wall netting for backstop and security curtain to the range.

### WALL

Height: 1.8m interlockable  
Hook the nets to each other!  
Length: maximum 25m

We deliver the ordered length but one WALL is 25 meters long.



**NEW**

### ≡F5 Multi Target with handle

40x40x40 cm

100%  
≡P*i*



### ≡F3A ≡P Target 65x65

65x65x22 cm

### ≡F3 ≡P Target 44x44

44x44x22 cm

100%  
≡P*i*



### ≡HYP ≡P Hypercube

53x53x53 cm

100%  
≡P*i*



### RENOVATING kit

Available 10 cm or 14 cm diameter,  
1 meter long rod from ≡P material.  
Colours are same as the basic colours of  
≡LEVEN 3D targets:  
white, grey, black, sand, brown

**NEW**

100%  
≡P*i*



Recommended for rainy conditions



According to the most 3D Rules



Durability



Price-Value Ratio



Arrow Pulling



Weight



Size



# Extra Strong Target

Recommended for Compound bow up to 60#

- E F1a 45x45x22 cm
- E F1b 60x60x22 cm
- E F1c 80x80x22 cm
- E F1d 90x90x22 cm
- E F1e 100x70x22 cm
- E F1f 100x100x22 cm
- E F1g 125x125x22 cm

E ST3 Stand,  
3 legs for Field



## E P Inserts

- E F2 9,5x25 cm
- E F2a 14,5x25 cm
- E F2b 24,5x25 cm
- E F2e 30x25 cm
- E F2c 37,5x25 cm
- E F2d 50x25 cm

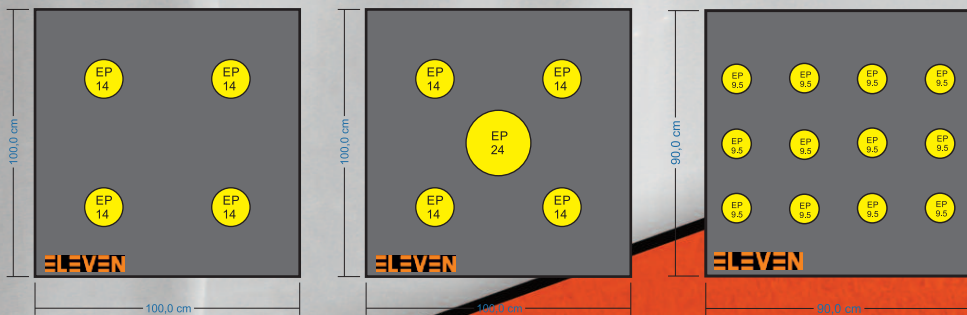
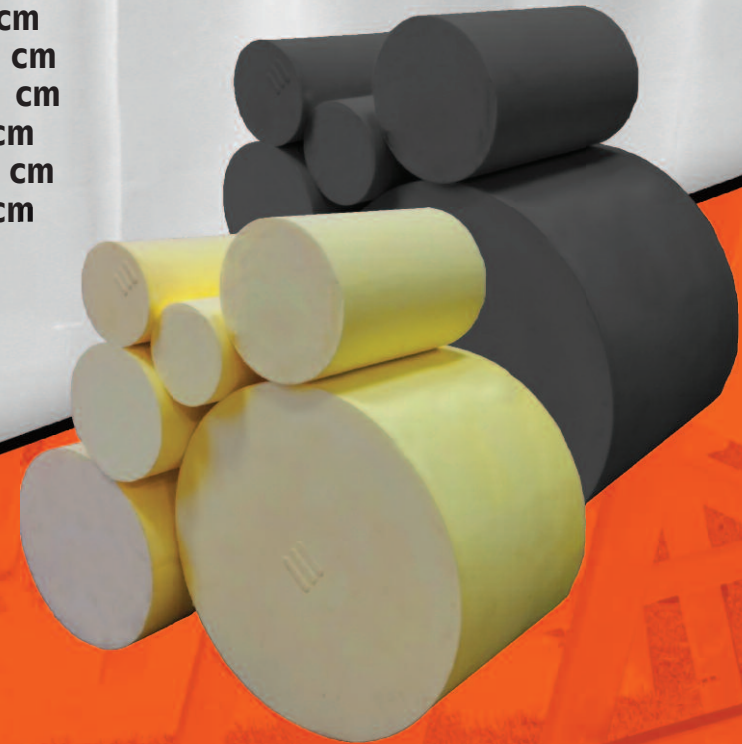



# ELEVEN+ series

Effective stop in all weather conditions for all bows and arrows.

- E+6060 60x60x20 cm
- E+8080 80x80x20 cm
- E+70100 70x100x20 cm
- E+100100 100x100x20 cm
- E+125125 125x125x20 cm



for indoor



for recurve

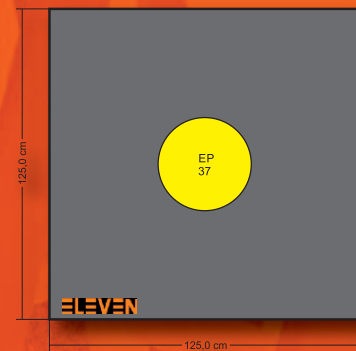

for outdoor

for indoor

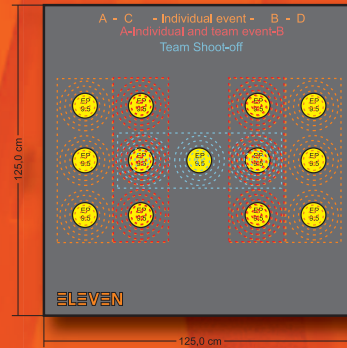

for compound

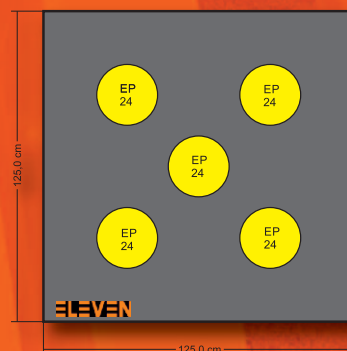

for outdoor



TARGET ARCHERY

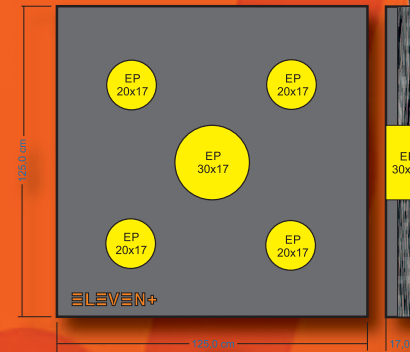

## ELEVEN+ Slim

- Easy storage
- Economical shipping
- Good price
- Only available in 125x125x17 cm size with 1 pcs 30x17 cm and 4 pcs 20x17 cm inserts

Replacable inserts for ELEVEN+ Slim

E+S20 EP insert 20x17 cm

E+S30 EP insert 30x17 cm



Recommended for rainy conditions



According to the most 3D Rules



Durability



Price-Value Ratio



Arrow Pulling



Weight



Size



# ≡COWAVE≡

≡conomical & ecological solutions  
125x125x20 cm



**TROL Trolley**  
for ≡LEVEN Targets  
System Symbiosis of an  
≡COWAVE≡ , an 4-leg  
Stand and Trolley.  
Life is easy with ≡LEVEN



## IF 10 is the maximum get ≡LEVEN

As arrow and bow technology is rapidly developing it is now necessary to have a new generation of targets on the archery market. ≡leven has always been a pioneer when it comes to inventions on the target market. The "≡CO" name reflects the reduced ecological footprint we leave since 80% of the weight is recycled material. The "≡CO" also reflects that this product is economically correct for the customer, since it is cheaper than any other solution with the highest quality level. A cheaper product with higher quality is a good combination making ≡COWAVE≡ unbeatable.



We have put all available knowledge and required material in this product to achieve:

- arrow stop at any weather condition, at any pundance, any type of arrow
- unbeatable durability with ≡ASY PULL inserts
- arrow saving technology (longer arrow-life)
- easy pulling for to archer with ≡ASY PULL inserts
- modular solution the make target handling easier
- any target type or variation can be built and adopted to your needs



To achieve all the required features above a high density shared of recycled material is used. High density means heavier targets. ≡cowave is heavier than our previous targets of the same size. This is one of the reason why we use the modular system. The other one is the high grade of flexibility it gives our customer to have the target customized to their needs at different events or different stage of one event.

Recommended for fix ranges

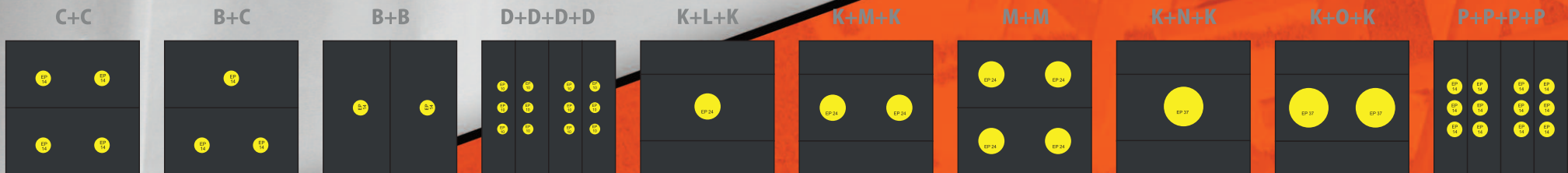



# Modular Solutions for maximum flexibility

TARGET ARCHERY

EP stick lock

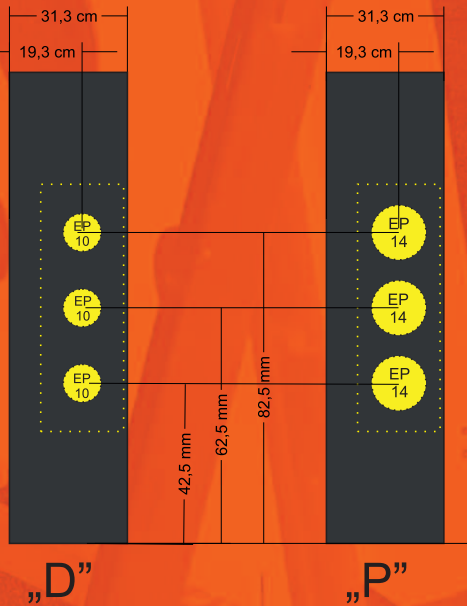
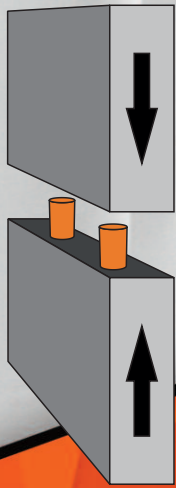

„A”

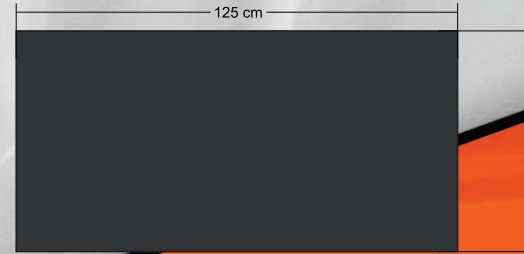

„K”



„B”

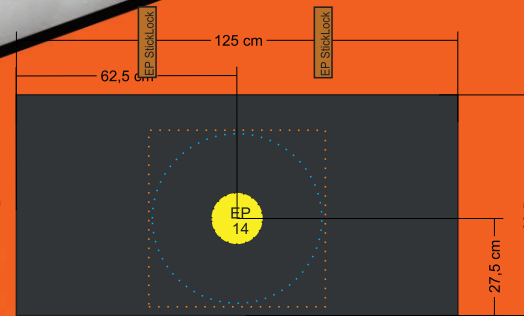

„L”

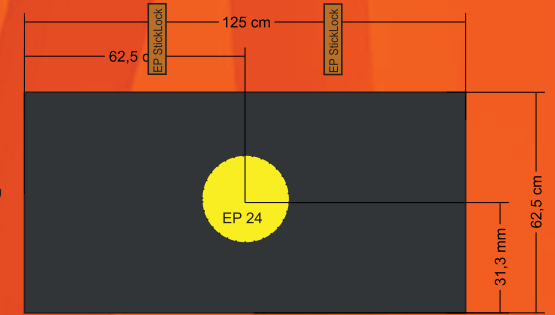

„C”

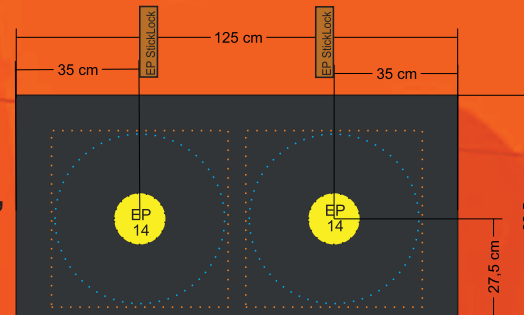

„M”

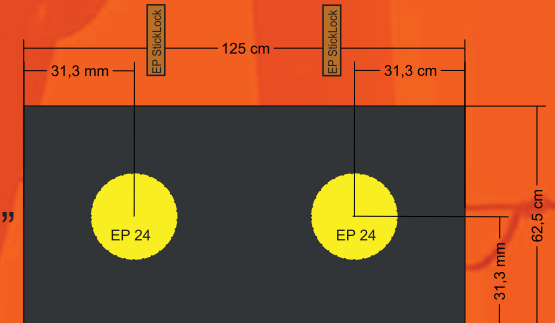

„N”

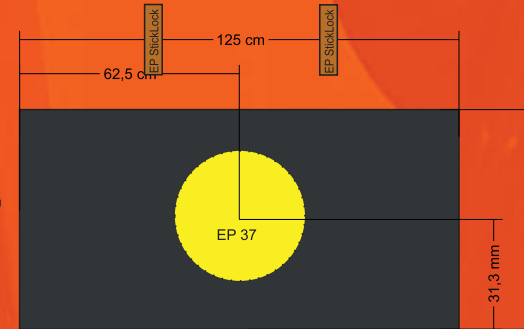

„O”

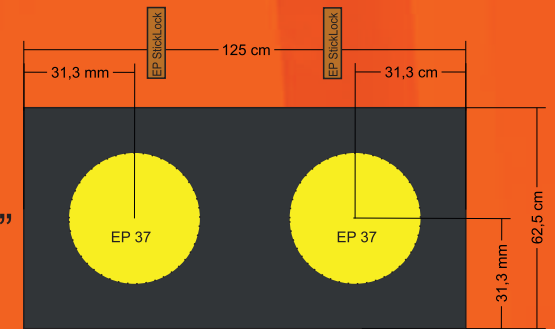

Order the elements according to code.



Recommended for rainy conditions



According to the most 3D Rules



Durability



Price-Value Ratio



Arrow Pulling



Weight



Size



# TARGET ARCHERY



## Extra Strong Target

Recommended for Compound bow to 60#

- F1d 90x90x22 cm
- F1e 100x70x22 cm
- F1f 100x100x22 cm
- F1g 125x125x22 cm

## F2 P Insert in GREY

Same product, same quality in other colour!

Choose the P inserts in neutral grey

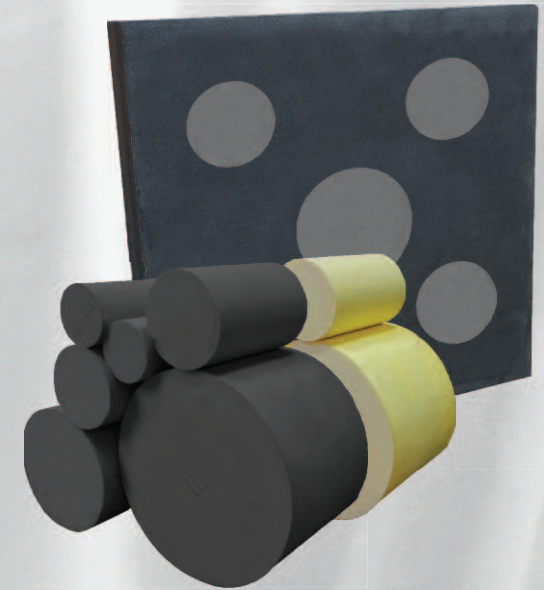

## RECOMMENDATION

	PRO	CO	+	+ Slim	ELEVEN EXTRA STRONG	ELEVEN STANDARD	START	P Target & MultiTarget	P10	P14	P24	P37	P50
Sizes	60x60, 80x80, 100x100, 125x125,	125x125 Modular	60x60, 80x80, 100x70, 100x100, 125x125	125x125	45x45, 60x60, 80x80, 90x90, 100x70, 100x100, 125x125	60x60, 80x80, 100x100, 125x125	60x60, 80x80, 100x100	44x44, 65x65, 40x40x40	Ø9.5 cm	Ø14.5 cm	Ø24.5 cm	Ø37 cm	Ø50 cm
Thickness	7 cm	22 cm	20 cm	17 cm	22 cm	25 cm	7 / 14 cm	25 cm	25 cm	25 cm	25 cm	25 cm	25 cm
For Beginners	≡	≡	≡	≡	≡	≡	≡	≡	≡	≡	≡	≡≡	≡≡≡
For Hunters	≡≡≡	≡	≡≡≡	≡	≡≡	≡	-	≡≡≡	≡≡	≡≡	≡≡≡	≡≡≡	≡≡
For Competitors	≡≡	≡≡≡	≡≡	≡≡≡	≡≡	≡	-	≡≡≡	≡≡≡	≡≡≡	≡≡≡	≡≡≡	≡≡
For Traditional	≡	≡	≡	≡	≡	≡≡≡	≡≡	≡	≡	≡	≡≡≡	≡≡≡	≡≡≡
For Target archery	≡	≡≡≡	≡≡	≡≡≡	≡≡	≡	-	≡	≡≡≡	≡≡≡	≡≡≡	≡≡≡	≡≡≡
For Field archery	≡	≡	≡≡≡	≡	≡≡≡	≡	-	≡	≡≡≡	≡≡≡	≡≡≡	≡≡≡	≡
For 3D practice	≡≡≡	≡	≡≡	≡	≡≡	≡≡	-	≡≡≡	≡≡≡	≡≡≡	≡≡≡	≡≡≡	≡≡≡
For rainy conditions	≡≡≡	≡≡≡	≡≡≡	≡≡≡	≡≡	≡	≡	≡≡≡	≡≡≡	≡≡≡	≡≡≡	≡≡≡	≡≡≡
For easy carrying	≡≡≡	≡	≡≡	≡≡	≡≡≡	≡≡≡	≡≡≡	≡≡≡	≡≡≡	≡≡≡	≡≡≡	≡≡≡	≡≡≡
ECO friendly	≡≡≡	≡≡≡	≡≡≡	≡≡≡	≡	≡	≡	≡≡	≡≡	≡≡	≡≡	≡≡	≡≡
Low budget	≡≡≡	≡≡	≡≡≡	≡≡	≡	≡	≡≡≡	≡≡	≡≡	≡≡	≡≡	≡≡	≡≡

≡ little match

≡≡ recommended

≡≡≡ best choice



# THE WALL netting

Weight: 1,8 kilograms/m (1,8 m<sup>2</sup>).  
 Height of net is 1,8m that can be attached to another netting, doubling the height.

We deliver the ordered length (1-25m),  
 the one standard unit is maximum 25m.



hangup



interlockable



# TROL The Trolley

95x235x115 cm  
 Easy moving of COWAVE targets with THE TROLLEY.  
 Works with 4 Legs STAND!

THE STAND and THE TROLLEY with COWAVE or LEVEN+ buttress  
 Smart combinations from the LEVEN Targets

# ST4 STAND 4 Legs

193x120x16 cm (stock size)  
 Fixed angles for outdoor and indoor usage



Thickness only 16 cm!



Recommended for rainy conditions



According to the most 3D Rules



Durability



Price-Value Ratio



Arrow Pulling



Weight



Size



## HISTORICAL ARCHERY



### ≡F6 Standard Target

Recommended for Recurve Bow to 50#

- ≡F6a 60x60x22 cm
- ≡F6b 80x80x22 cm
- ≡F6c 100x100x22 cm
- ≡F6d 125x125x22 cm

### PUTA with dots

120x90x25 cm

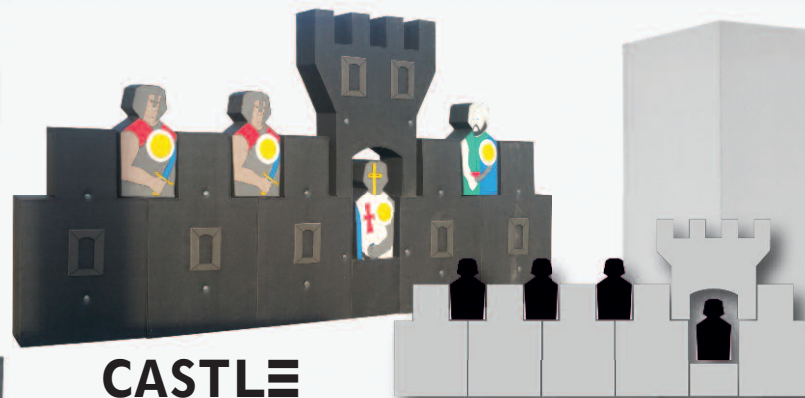

### CASTLE

510x175x25 cm

### SLD Castle Soldier

85x40x20 cm



### ≡F4g Silhouette

85x40x20 cm



### THE WALL netting

Stops all wooden arrows.  
Height: 1.8 m, interlockable  
Length: maximum 25 m



### Backstop series

#### ≡PRO series

- ≡PRO60 60x60x7 cm
- ≡PRO80 80x80x7 cm
- ≡PRO100 100x100x7 cm
- ≡PRO125 125x125x7 cm

- ≡F4a 80x80x10 cm
- ≡F4b 80x110x10 cm
- ≡F4c 100x100x10 cm
- ≡F4d 130x130x10 cm
- ≡F4e 80x200x10 cm
- ≡F4f 150x200x10 cm





## DSC Discs

- DSC25 25x7 cm
- DSC30 30x7 cm
- DSC40 40x7 cm



## START COLOUR

- ≡F60c 60x60x7 cm
- ≡F80c 80x80x7 cm



## Stand for START series

- HS1 60x20x7 cm
- HS2 80x20x7 cm
- HS3 100x20x7 cm
- HS6 60x20x7/14 cm
- HS7 80x20x7/14 cm



## START Targets

- ≡S1 60x60x7 cm
- ≡S2 80x80x7 cm
- ≡S3 100x100x7 cm
- ≡S4 60x60x14 cm
- ≡S5 80x80x14 cm
- ≡S6 100x100x14 cm

## ST60SET START set

65x65x9 cm

include:

- 60x60 cm butt
- wooden leg with instructions
- targets face
- pins



## ≡PRO60SET ≡PRO set

65x65x9 cm

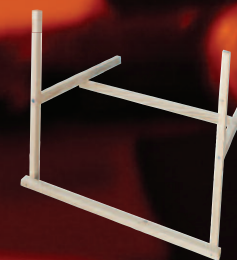

Recommended for rainy conditions



According to the most 3D Rules



Durability



Price-Value Ratio



Arrow Pulling



Weight



Size



# Season is never over with ELEVEN Targets

www.  
**ELEVEN**  
T A R G E T S . h u

H-1163 Budapest, Margit u. 28.  
E-mail: [info@eleventargets.hu](mailto:info@eleventargets.hu)  
Tel.: +3630-228-3702

All Eleven targets are made in the EU, Hungary

Some product may differ from the images  
displayed in the catalogue.

Eleven hold the rights to change, alter or remove  
products from production.

