

www

LEVELLEN

T A R G E T S .hu



Full of

IDEAS

2016 - 2017



FULL OF IDEAS

We started with 3D targets in 2003. After 3 years of experience 2006 we started producing EP (Easy Pull) material. 3D targets and inserts inserted in polyfoam targets for target and field archery. The inserts can be adjusted according to the different rules and all other needs our customers may have. Our products are used by clubs and associations that wants to have long lasting targets but also on the highest level competitions like World Cups and World Championships. During the development, we experimented with materials that are flexible, resistant against physical load, but at the same time don't damage the arrows. During our researches, we concluded that due to the mode of usage, it is not one, but a combination of materials that must be used to satisfy all needs. We constantly work on developing new materials and products and making existing products better and more price worthy. We strive every minute to live and act according to our slogan: „Full of ideas”, this is best for our customer.



2002
Founded ELEVEN

2003
3D Targets

2003
Developed EP

2005
Buttress from polyfoam

2006
EP inserts in buttress
EP inserts in 3D targets

2007
EP multitarget

2008
Modular buttress system

2009

NEWS



HOLE IN ONE!

NEW

We use material where it is needed, you save money without making compromises. It looks the same, lasts as long, feels the same but costs less.

Sometimes less is more...



2010

2011

2012

2013

The WALL netting

2014

Developed **ECO**
PRO

2014

Fun archery products
EVEN+ butts

2015

EVEN+ Slim

2016

Hole In technology

3D TARGETS



E5 Rabbit

30x51x22 cm



E27 Small Piggie

51x30x22 cm

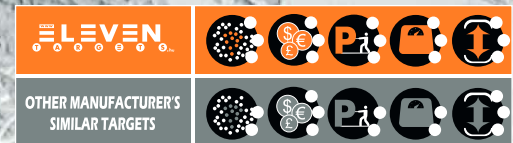

E49 Nutria

48x21x26 cm



E36 Hare

E36A Arctic Hare

20x40x22 cm





E37 Falcon
18x48x20 cm

100% EPI GROUP 4

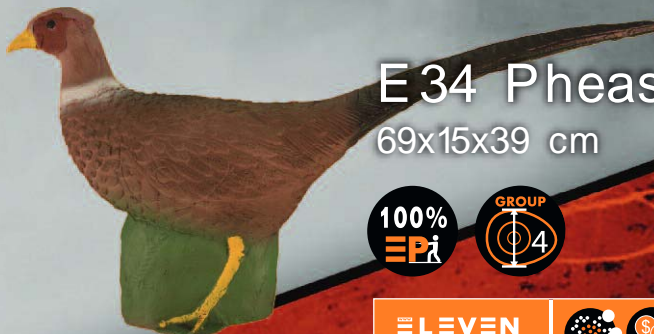

E34 Pheasant
69x15x39 cm

100% EPI GROUP 4

LEVEN	
OTHER MANUFACTURER'S SIMILAR TARGETS	



E7 Owl
22x52x20 cm

100% EPI GROUP 4

E50 Whistler
21x21x56 cm

100% EPI GROUP 4 NEW

LEVEN	
OTHER MANUFACTURER'S SIMILAR TARGETS	



E26 Turkey
30x66x32 cm

100% EPI GROUP 4



Peak performance - EP material

- The material is SELF-HEALING able to take thousand of shots without any pass through
- In average they last 3,7 times longer
- The arrow pull is an average 53% easier
- Our EP targets are in average 26% cheaper



Recommended for rainy conditions



According to the most 3D Rules



Durability



Price-Value Ratio



Arrow Pulling



Weight



Size

3D TARGETS



E 56 Varanus
50x23x13 cm

NEW **100% EPI** **GROUP 4**



E 39 Carp
68x18x15 cm

100% EPI **GROUP 4**

E 22 Crocodile
112x33x28 cm

100% EPI **GROUP 4**



E 32 Goose
59x21x52 cm

100% EPI **GROUP 4**

E 41 Marten

17x39x18 cm



E 33 Duck

41x23x18 cm



E 2 Badger

46x66x26 cm



E 40 Otter

60x30x26 cm



E 1 Fox

E 1A Arctic Fox

39x54x25 cm



LEVEN					
OTHER MANUFACTURER'S SIMILAR TARGETS					



Recommended for rainy conditions



According to the most 3D Rules



Durability



Price-Value Ratio



Arrow Pulling



Weight



Size

3D TARGETS



E 14A Cougar
E 14 Black Panther
95x58x30 cm



E 42 Wolverine
90x55x25 cm



E 6 Wolf
95x58x23 cm



E 47 Bedded Boar
95x40x30 cm



NEW



E 52 Bubo Owl
70x27x35 cm

100% **EPi** **GROUP 3**

LEVEN					
OTHER MANUFACTURER'S SIMILAR TARGETS					



E 57 Shark
145x50x40 cm

100% **EPi** **GROUP 3** **HOLE IN**



E 48 Blackcock
65x28x50 cm

100% **EPi** **GROUP 3**

LEVEN					
OTHER MANUFACTURER'S SIMILAR TARGETS					



Recommended for rainy conditions



According to the most 3D Rules



Durability



Price-Value Ratio



Arrow Pulling



Weight



Size

3D TARGETS



E3 Pecari

78x56x27 cm



E 13 Bedded Deer

82x45x27 cm

E 13H The horns are sold separately!

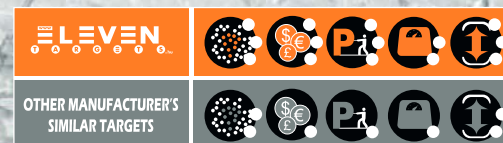

E 13A Bedded Deer (dark)

82x45x27 cm

E 13H The horns are sold separately!

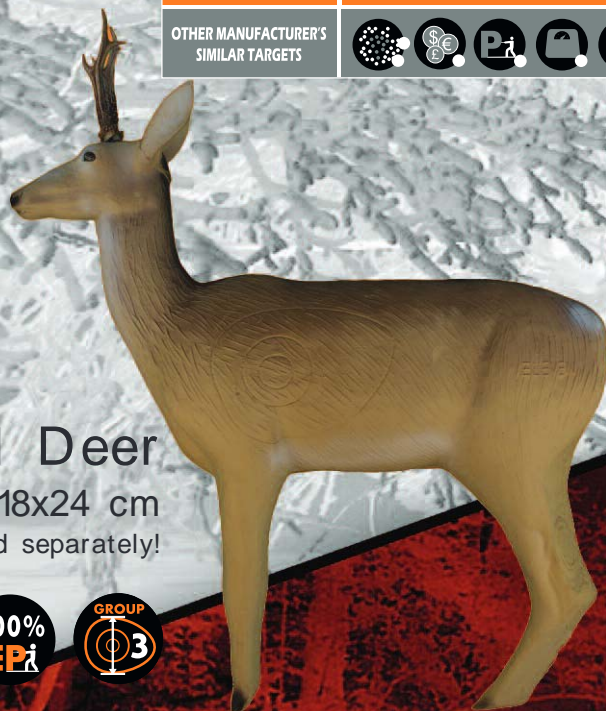

E 11 Deer

109x118x24 cm

E 13H The horns are sold separately!



E 11A Deer (dark)

109x118x24 cm

E 13H The horns are sold separately!





E46 Leaping deer

115x100x25 cm

E46H The horns are sold separately!



ELEVEN					
OTHER MANUFACTURER'S SIMILAR TARGETS					



E30 Fallow Deer

125x87x30 cm

E30H The horns are sold separately!



E55 Lynx

67x70x24 cm



ELEVEN					
OTHER MANUFACTURER'S SIMILAR TARGETS					



Recommended for rainy conditions



According to the most 3D Rules



Durability



Price-Value Ratio



Arrow Pulling



Weight



Size

3D TARGETS



E21 Wild Boar Medium

95x60x30 cm



E29 Sitting Wolf

45x85x28 cm



E38 Turtle

54x100x44 cm



3D TARGETS

E 44 Chamois

100x61x25 cm



E 43 Ibex

110x95x25 cm



OTHER MANUFACTURER'S SIMILAR TARGETS					



E 12 Sheep

103x112x25 cm



OTHER MANUFACTURER'S SIMILAR TARGETS					



Recommended for rainy conditions



According to the most 3D Rules



Durability



Price-Value Ratio



Arrow Pulling



Weight



Size

3D TARGETS



E 44 Elk

200x147x35 cm

E 44H The horns are sold separately!

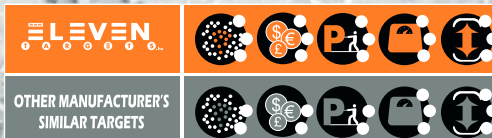

E 15 Stag

170x154x42 cm

E 15H The horns are sold separately!



E 31 Mountain Goat

125x96x34 cm



E 53 Wolf
w insert
115x73x25 cm

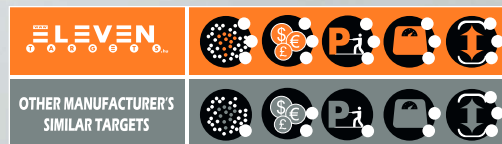

E 8 Wild Boar
123x67x37 cm



E 35 Tiger
173x89x36 cm



E 35A Lion
173x89x36 cm



Recommended for rainy conditions



According to the most 3D Rules



Durability



Price-Value Ratio



Arrow Pulling



Weight



Size

3D TARGETS



E54 Bear with insert
E54A Dark Bear with insert
E54P Polar Bear with insert
119x84x28 cm

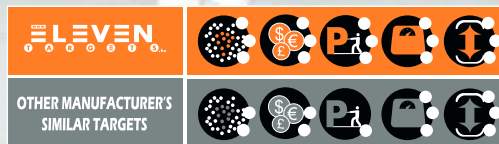

NEW New Products

100% EP Targets made out of 100% EasyPull Material

HOLE IN HOLE IN technology

3D EP 3D targets with removable EP inserts

EP Easy Pull Material insert can be ordered separately

ECO ECO solutions

+ Modular solutions

E20 Standing Bear

58x207x55 cm

E20P Standing Polar Bear

58x207x55 cm





NEW **HOLE IN**

Sometimes less is more. In our efforts to create more value to our customers a solution emerged that is new on the 3D market. As foam material is really expensive if you want to reduce price there are two ways to go. Reduce the weight of material meaning less material put in the targets, which is the path others walk resulting poorer quality targets. We do not want to make compromises on the well-known extraordinary quality of Eleven targets so we looked at where it is not necessary to have material at all, as cheapest material on earth at the moment is air being free of charge. If we have a hole where targets are not used to much but we still have enough foam to stop just in case any arrow is shot there was the solution. HOLE IN was born. Same quality, same feeling, same durability to a reduced price. We are proud to present the HOLE IN series.



Recommended for rainy conditions



According to the most 3D Rules



Durability



Price-Value Ratio



Arrow Pulling



Weight



Size

3D ACCESSORIES

Backstop series

- EF4a 80x80x10 cm
- EF4b 80x110x10 cm
- EF4c 100x100x10 cm
- EF4d 130x130x10 cm
- EF4e 80x200x10 cm
- EF4f 150x200x10 cm



EPRO series for practice or as backstop for maximum protection

- EPRO60 60x60x7 cm
- EPRO80 80x80x7 cm
- EPRO100 100x100x7 cm
- EPRO125 125x125x7 cm



E3DST Premium Stand for 3D

For all ELEVEN 3D targets... From the smallest to the largest. Easy installing and **stable** position.



The Wall netting for backstop and security curtain to the range.

WALL

Height: 1.8m interlockable
Hook the nets to each other!
Length: maximum 25m

We deliver the ordered length but one WALL is 25 meters long.



EF5 Multi Target with handle

40x40x40 cm



EF3A EP Target 65x65

65x65x22 cm

EF3 EP Target 44x44

44x44x22 cm



EHYP EP Hypercube

53x53x53 cm



RENOVATING kit

Available 10 cm or 14 cm diameter, 1 meter long rod from EP material. Colours are same as the basic colours of ELEVEN 3D targets: white, grey, black, sand, brown



Recommended for rainy conditions



According to the most 3D Rules



Durability



Price-Value Ratio



Arrow Pulling



Weight



Size

Extra Strong Target

Recommended for Compound bow up to 60#

- EF1a 45x45x22 cm
- EF1b 60x60x22 cm
- EF1c 80x80x22 cm
- EF1d 90x90x22 cm
- EF1e 100x70x22 cm
- EF1f 100x100x22 cm
- EF1g 125x125x22 cm

**EST3 Stand,
3 legs for Field**



EP Inserts

- EF2 9,5x25 cm
- EF2a 14,5x25 cm
- EF2b 24,5x25 cm
- EF2e 30x25 cm
- EF2c 37,5x25 cm
- EF2d 50x25 cm



ELEVEN+ series

Effective stop in all weather conditions for all bows and arrows.

- E+6060 60x60x20 cm
- E+8080 80x80x20 cm
- E+70100 70x100x20 cm
- E+100100 100x100x20 cm
- E+125125 125x125x20 cm



for indoor



for recurve

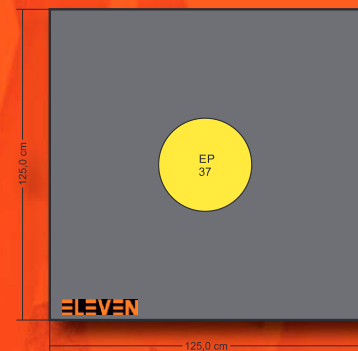

for outdoor

for indoor

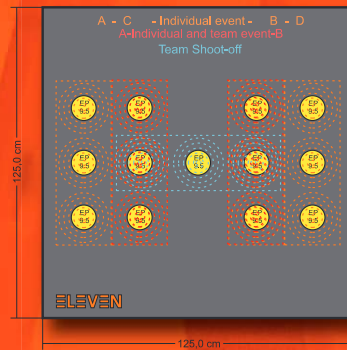

for compound

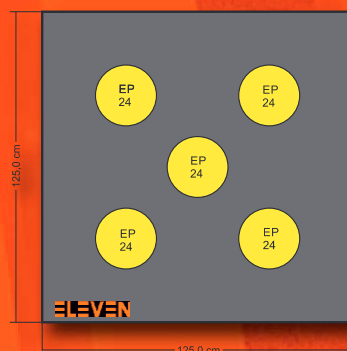

for outdoor

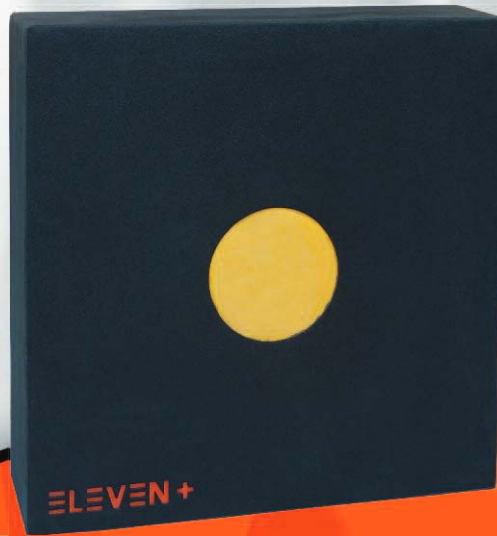

TARGET ARCHERY

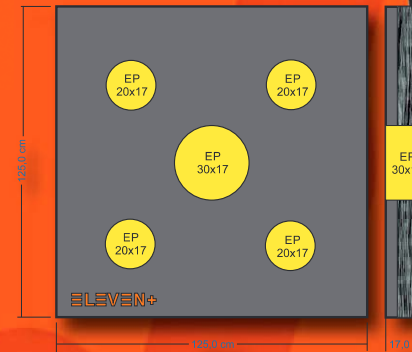

ELEVEN+ Sim

- Easy storing
- Economical shipping
- Good price
- Only available in 125x125x17 cm size with 1 pcs 30x17 cm and 4 pcs 20x17 cm inserts

Replacable inserts for Eleven+ Sim

E+S20 EP insert 20x17 cm

E+S30 EP insert 30x17 cm



Recommended for rainy conditions



According to the most 3D Rules



Durability



Price-Value Ratio



Arrow Pulling



Weight



Size

ECOWAVE

Economical & ecological solutions
125x125x20 cm



TROL Trolley
for ELEVEN Targets
System Symbiosis of an
ECOWAVE , an 4-leg
Stand and Trolley.
Life is easy with ELEVEN



IF 10 is the maximum get ELEVEN

As arrow and bow technology is rapidly developing it is now necessary to have a new generation of targets on the archery market. Eleven has always been a pioneer when it comes to inventions on the target market. The "ECO" name reflects the reduced ecological footprint we leave since 80% of the weight is recycled material. The "ECO" also reflects that this product is economically correct for the customer, since it is cheaper than any other solution with the highest quality level. A cheaper product with higher quality is a good combination making ECOWAVE unbeatable.



We have put all available knowledge and required material in this product to achieve:

- arrow stop at any weather condition, at any pundance, any type of arrow
- unbeatable durability with EASY PULL inserts
- arrow saving technology (longer arrow-life)
- easy pulling for to archer with EASY PULL inserts
- modular solution the make target handling easier
- any target type or variation can be built and adopted to your needs



To achieve all the required features above a high density shared of recycled material is used. High density means heavier targets. Ecowave is heavier than our previous targets of the same size. This is one of the reason why we use the modular system. The other one is the high grade of flexibility it gives our customer to have the target customized to their needs at different events or different stage of one event.

Recommended for fix ranges



Modular Solutions for maximum flexibility

TARGET ARCHERY

EP stick lock

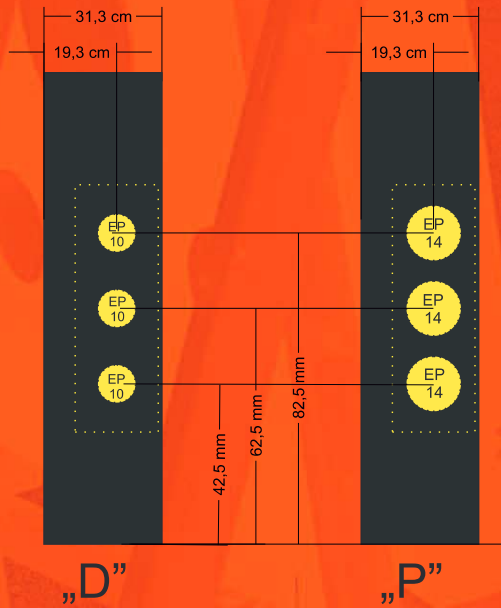
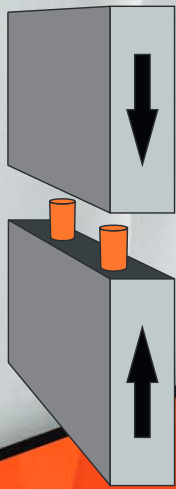

„A”

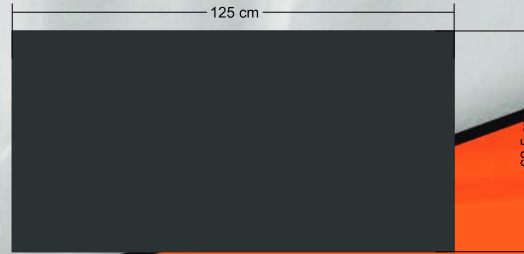

„B”

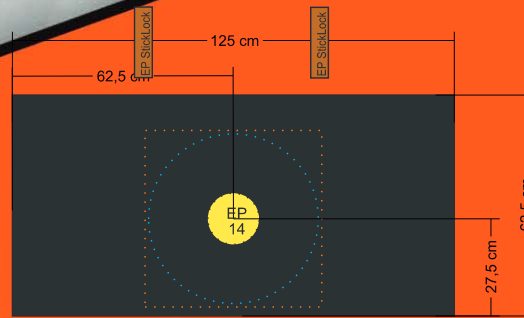

„C”

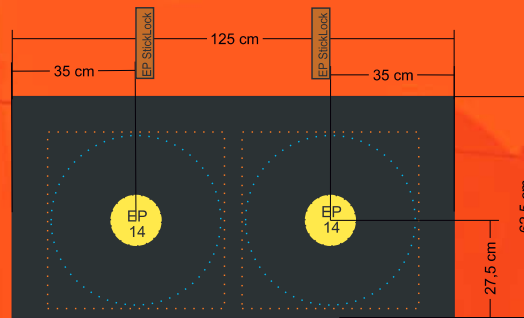

„N”

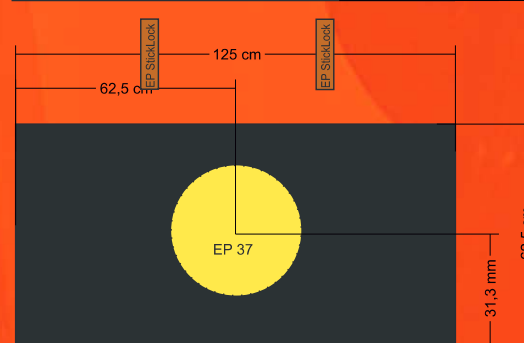

„K”

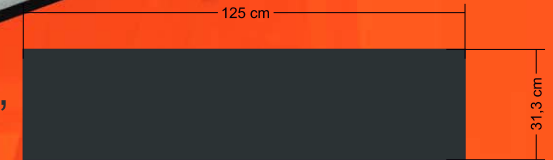

„L”

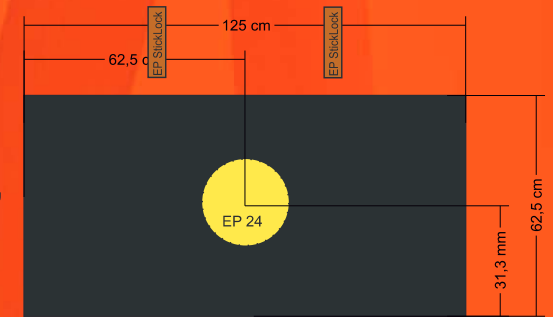

„M”

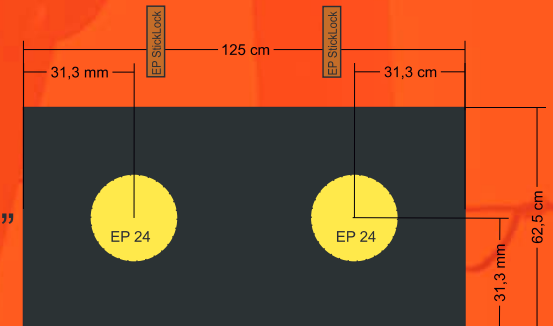

„O”



Order the elements according to code.



Recommended for rainy conditions



According to the most 3D Rules



Durability



Price-Value Ratio



Arrow Pulling



Weight



Size

TARGET ARCHERY



Extra Strong Target

Recommended for Compound bow to 60#

- EF1d 90x90x22 cm
- EF1e 100x70x22 cm
- EF1f 100x100x22 cm
- EF1g 125x125x22 cm

EF2 EP Insert in GREY

Same product, same quality in other colour!

Choose the EP inserts in neutral grey

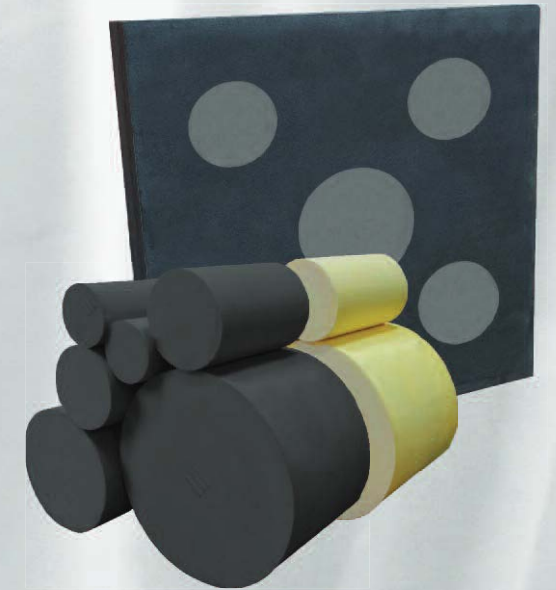

RECOM MENDATION

	PRO	ECO	+	+ Slim	ELEVEN EXTRA STRONG	ELEVEN STANDARD	START	EP Target & MultiTarget	EP10	EP14	EP24	EP37	EP50
Sizes	60x60, 80x80, 100x100, 125x125,	125x125 Modular	60x60, 80x80, 100x70, 100x100, 125x125	125x125	45x45, 60x60, 80x80, 90x90, 100x70, 100x100, 125x125	60x60, 80x80, 100x100, 125x125	60x60, 80x80, 100x100	44x44, 65x65, 40x40x40	Ø9.5 cm	Ø14.5 cm	Ø24.5 cm	Ø37 cm	Ø50 cm
Thickness	7 cm	22 cm	20 cm	17 cm	22 cm	25 cm	7 / 14 cm	25 cm	25 cm	25 cm	25 cm	25 cm	25 cm
For Beginners	≡	≡	≡	≡	≡	≡	≡	≡	≡	≡	≡	≡≡	≡≡≡
For Hunters	≡≡≡	≡	≡≡≡	≡	≡≡	≡	-	≡≡≡	≡≡	≡≡	≡≡≡	≡≡≡	≡≡
For Competitors	≡≡	≡≡≡	≡≡	≡≡≡	≡≡	≡	-	≡≡≡	≡≡≡	≡≡≡	≡≡≡	≡≡≡	≡≡
For Traditional	≡	≡	≡	≡	≡	≡≡≡	≡≡	≡	≡	≡	≡≡≡	≡≡≡	≡≡≡
For Target archery	≡	≡≡≡	≡≡	≡≡≡	≡≡	≡	-	≡	≡≡≡	≡≡≡	≡≡≡	≡≡≡	≡≡≡
For Field archery	≡	≡	≡≡≡	≡	≡≡≡	≡	-	≡	≡≡≡	≡≡≡	≡≡≡	≡≡≡	≡
For 3D practice	≡≡≡	≡	≡≡	≡	≡≡	≡≡	-	≡≡≡	≡≡≡	≡≡≡	≡≡≡	≡≡≡	≡≡≡
For rainy conditions	≡≡≡	≡≡≡	≡≡≡	≡≡≡	≡≡	≡	≡	≡≡≡	≡≡≡	≡≡≡	≡≡≡	≡≡≡	≡≡≡
For easy carrying	≡≡≡	≡	≡≡	≡≡	≡≡≡	≡≡≡	≡≡≡	≡≡≡	≡≡≡	≡≡≡	≡≡≡	≡≡≡	≡≡≡
ECO friendly	≡≡≡	≡≡≡	≡≡≡	≡≡≡	≡	≡	≡	≡≡	≡≡	≡≡	≡≡	≡≡	≡≡
Low budget	≡≡≡	≡≡	≡≡≡	≡≡	≡	≡	≡≡≡	≡≡	≡≡	≡≡	≡≡	≡≡	≡≡
	≡ little match				≡≡ recommended			≡≡≡ best choice					

THE WALL netting

Weight: 1,8 kilograms/m (1,8 m²).
 Height of net is 1,8m that can be attached to another netting, doubling the height.

We deliver the ordered length (1-25m), the one standard unit is maximum 25m.



hangup



interlockable



TROL The Trolley

95x235x115 cm

Easy moving of ECOWAVE targets with THE TROLLEY.
 Works with 4 Legs STAND!

THE STAND and THE TROLLEY with ECOWAVE or ELEVEN+ buttress
 Smart combinations from the ELEVEN Targets

Thickness only 16 cm!

EST4 STAND 4 Legs

193x120x16 cm (stock size)
 Fixed angles for outdoor and indoor usage



Recommended for rainy conditions



According to the most 3D Rules



Durability



Price-Value Ratio



Arrow Pulling



Weight



Size

HISTORICAL ARCHERY



EF6 Standard Target

Recommended for Recurve Bow to 50#

- EF6a 60x60x22 cm
- EF6b 80x80x22 cm
- EF6c 100x100x22 cm
- EF6d 125x125x22 cm

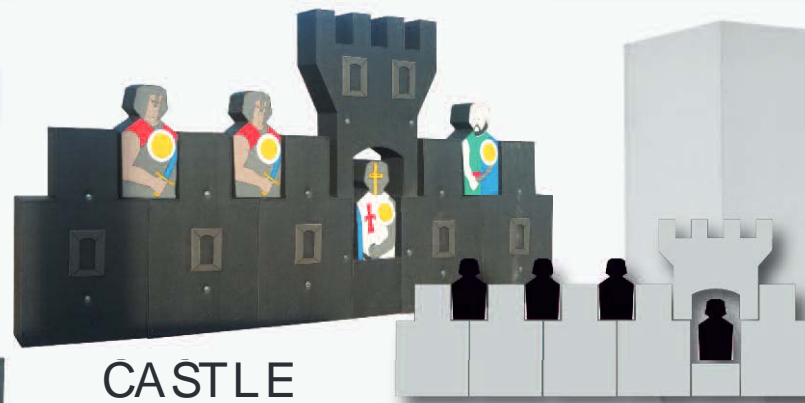

CASTLE

510x175x25 cm



THE WALL netting

Stops all wooden arrows.
Height: 1.8 m, interlockable
Length: maximum 25 m



SLD Castle Soldier

85x40x20 cm



EF4g Silhouette

85x40x20 cm



Backstop series

- EF4a 80x80x10 cm
- EF4b 80x110x10 cm
- EF4c 100x100x10 cm
- EF4d 130x130x10 cm
- EF4e 80x200x10 cm
- EF4f 150x200x10 cm



PUTA with dots

120x90x25 cm



EPRO series

- EPRO60 60x60x7 cm
- EPRO80 80x80x7 cm
- EPRO100 100x100x7 cm
- EPRO125 125x125x7 cm

DSC Discs

- DSC25 25x7 cm
- DSC30 30x7 cm
- DSC40 40x7 cm



START COLOUR

- EF60c 60x60x7 cm
- EF80c 80x80x7 cm



Stand for START series

- HS1 60x20x7 cm
- HS2 80x20x7 cm
- HS3 100x20x7 cm
- HS6 60x20x7/14 cm
- HS7 80x20x7/14 cm



START Targets

- ES1 60x60x7 cm
- ES2 80x80x7 cm
- ES3 100x100x7 cm
- ES4 60x60x14 cm
- ES5 80x80x14 cm
- ES6 100x100x14 cm

ST60SET START set

65x65x9 cm

include:

- 60x60 cm butt
- wooden leg with instructions
- targets face
- pins



EPRO60SET EPRO set

65x65x9 cm

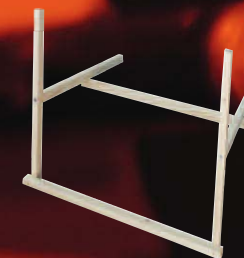

Recommended for rainy conditions



According to the most 3D Rules



Durability



Price-Value Ratio



Arrow Pulling



Weight



Size

Season is never over with **ELEVEN** Targets

www.**ELEVEN**
T A R G E T S . h u

H-1163 Budapest, Margit u. 28.
E-mail: info@eleventargets.hu
Tel.: +3630-228-3702

All Eleven targets are made in the EU, Hungary

Some product may differ from the images
displayed in the catalogue.

Eleven hold the rights to change, alter or remove
products from production.



